







GrifStyl®

CATÁLOGO 2019

LINEA TRADICIONAL BAÑO

	PÁGINA
	SERIE LONDON 1899 MODELO VICTORIAN 9-11
	SERIE LONDON 1899 MODELO EDWARDIAN 13-15
	SERIE LONDON 1899 MODELO BERKELEY 17-19
	SERIE STYL 1900 21-23
	SERIE TRADICIONAL - MODELO GUADIANA 24-25

LINEA MONOMANDO BAÑO

	SERIE G3000 28-29
	SERIE AURA 30-32
	SERIE OMBRIA 33
	SERIE NEO 34
	SERIE ARES 35



LINEA MONOMANDO BAÑO



SERIE BETA – OMEGA

36-37



SERIE ALFA

36-37

LINEA COCINA



MONOMANDOS FREGADERO REPISA CROMO

40-43-44



MONOMANDOS PARED Y EXTRAIBLE

41



MONOMANDOS FREGADERO REPISA COLOR CAÑO FUNDIDO

42-43



MONOMANDOS FREGADERO REPISA COLOR

44



MONOMANDOS FREGADERO FLEXIBLE Y ARTICULADO

45



GRIFERÍA COCINA TRADICIONAL

46-47



GRIFERÍA COCINA OSMOSIS Y PELUQUERÍA

47

LINEAS ESPECIFICAS



SERIE UN AGUA Y GRIFO HIGIÉNICO

48-49



SERIE SANITARIA

50



COMPLEMENTOS Y REPUESTOS DE GRIFERÍA	51-61
FLUXÓMETROS KRIBA Y REPUESTOS	63-65
GRIFERÍA TEMPORIZADA , FUENTE Y DE PEDAL	66-68
JUNTAS - TAPONES - GOMAS - MEMBRANAS - ESTUCHES -TEFLÓN - SOLDAR	69-78
GRIFOS - LLAVES - VÁLVULAS - BOCAS DE RIEGO	79-82
BOYAS - FLOTADORES	83-84
PLACAS - VÁLVULAS RETENCIÓN - MONTURAS	85
RACORERIA LATÓN ESTAMPADO	86-91
ACCESORIO LATÓN TUBERÍA HIERRO	92-95
ACCESORIO LATÓN TUBERÍA COBRE	96-100
PLAFONES - ARANDELAS - SISTEMAS SUJECCIÓN	100-101
DIFUSORES - SOPORTES Y TAPAS CALENTADOR	102
REJILLAS VENTILACIÓN - MARCOS	103-104
SIFONES - VÁLVULAS FREGADERO/LAVABO/DUCHA/BAÑERA - TOMAS LAVADORA	105-108
ACCESORIOS INODORO Y CISTERNA	109-112
ACCESORIOS PVC GRIS	113-114
CONEXIONES FLEXIBLES ACERO INOX	115
CONDICIONES GENERALES DE VENTA	116
NOTAS	117





LINEA TRADICIONAL



BETEVERAL



SERIE LONDON 1899





500	Juego de Grifos lavabo 1/2"	150,10 €	199,70 €
501	Juego de grifos bañera 3/4"	188,99 €	239,70 €



502	Monobloc lavabo con desagüe automático	209,18 €	259,85 €
-----	--	----------	----------



503	Monobloc bidet con desagüe automático	219,80 €	269,35 €
-----	---------------------------------------	----------	----------



504	Batería lavabo caño central con desagüe automático	259,98 €	306,48 €
-----	--	----------	----------



505	Batería lavabo dos agujeros 6" (152 mm)	177,10 €	206,20 €
-----	---	----------	----------



507	Llenador de bañera con excéntricas	237,28 €	321,18 €
-----	------------------------------------	----------	----------



508	Grupo baño ducha completo con excéntricas	375,20 €	448,90 €
-----	---	----------	----------



509	Grupo baño ducha completo con codos para repisa	423,90 €	516,26 €
-----	---	----------	----------



510	Grupo baño ducha completo con columnas suelo	692,80 €	914,24 €
-----	--	----------	----------



511	Batería ducha completa con excéntricas	280,75 €	380,90 €
-----	--	----------	----------



514	Juego llaves de paso roscar 1/2 "	78,92 €	112,82 €
515	Juego llaves de paso roscar 3/4 "	84,90 €	118,70 €
517	Juego llaves de paso soldar 14 , 15 y 16 mm	78,92 €	112,82 €
518	Juego llaves de paso soldar 18 y 22 mm	84,90 €	118,70 €
523	Llave de escuadra de regulacion y corte 1/2" x 1/2 "	42,78 €	56,05 €



SERIE LONDON 1899





525	Juego de Grifos lavabo 1/2"	150,82 €	199,90 €
526	Juego de grifos bañera 3/4"	184,71 €	227,70 €



527	Monobloc lavabo con desagüe automático	219,90 €	268,90 €
-----	--	----------	----------



528	Monobloc bidet con desagüe automático	224,20 €	274,90 €
-----	---------------------------------------	----------	----------



529	Batería lavabo caño central con desagüe automático	268,90 €	334,95 €
-----	--	----------	----------



530	Batería lavabo dos agujeros 6" (152 mm)	182,82 €	215,25 €
-----	---	----------	----------



532	Llenador de bañera con excéntricas	242,50 €	326,55 €
-----	------------------------------------	----------	----------



533	Grupo baño ducha completo con excéntricas	383,20 €	456,70 €
-----	---	----------	----------



534	Grupo baño ducha completo con codos para repisa	431,90 €	524,26 €
-----	---	----------	----------



535	Grupo baño ducha completo con columnas suelo	700,80 €	922,24 €
-----	--	----------	----------



536	Batería ducha completa con excéntricas	288,75 €	380,90 €
-----	--	----------	----------



539	Juego llaves de paso roscar 1/2 "	86,92 €	120,82 €
540	Juego llaves de paso roscar 3/4 "	92,90 €	126,70 €
541	Juego llaves de paso soldar 14 , 15 y 16 mm	86,92 €	120,82 €
542	Juego llaves de paso soldar 18 y 22 mm	92,90 €	126,70 €
547	Llave de escuadra de regulación y corte 1/2" x 1/2 "	50,78 €	64,05 €



SERIE LONDON 1899





Grif Styl®

SERIE LONDON 1899
Modelo BERKELEY

PRECIO

CODIGO

PRODUCTO

CROMO

ORO



550	Juego de Grifos lavabo 1/2"	152,82 €	196,10 €
551	Juego de grifos bañera 3/4"	191,71 €	224,70 €



552	Monobloc lavabo con desagüe automático	222,90 €	270,90 €
-----	--	----------	----------



553	Monobloc bidet con desagüe automático	228,20 €	278,90 €
-----	---------------------------------------	----------	----------



554	Batería lavabo caño central con desagüe automático	275,90 €	321,95 €
-----	--	----------	----------



555	Batería lavabo dos agujeros 6" (152 mm)	189,82 €	222,25 €
-----	---	----------	----------



557	Llenador de bañera con excéntricas	249,50 €	333,55 €
-----	------------------------------------	----------	----------



558	Grupo baño ducha completo con excéntricas	390,20 €	463,70 €
-----	---	----------	----------



Grif Styl®

SERIE LONDON 1899
Modelo BERKELEY

PRECIO

CODIGO

PRODUCTO

CROMO

ORO



559	Grupo baño ducha completo con codos para repisa	438,90 €	531,26 €
-----	---	----------	----------



560	Grupo baño ducha completo con columnas suelo	707,80 €	929,24 €
-----	--	----------	----------



561	Batería ducha completa con excéntricas	295,75 €	395,90 €
-----	--	----------	----------



564	Juego llaves de paso roscar 1/2 "	93,92 €	127,82 €
565	Juego llaves de paso roscar 3/4 "	99,70 €	133,70 €
567	Juego llaves de paso soldar 14 , 15 y 16 mm	93,92 €	127,82 €
568	Juego llaves de paso soldar 18 y 22 mm	99,70 €	133,70 €





Grif Styl®

SERIE STYL 1900

PRECIO

CODIGO

PRODUCTO

CROMO

BRONCE

NEGRO MATE



4150	Juego grifos lavabo 1/2"	85,80 €	135,30 €	135,30 €
------	--------------------------	---------	----------	----------



4152	Monobloc lavabo	80,45 €	135,00 €	135,00 €
------	-----------------	---------	----------	----------



4151	Monobloc lavabo caño cisne	79,50 €	112,00 €	112,00 €
------	----------------------------	---------	----------	----------



4154	Bateria lavabo caño central	82,20 €	145,90 €	145,90 €
------	-----------------------------	---------	----------	----------



4158	Juego grifos bidet 1/2"	70,50 €	106,45 €	106,45 €
------	-------------------------	---------	----------	----------



Grif Styl®

SERIE STYL 1900

PRECIO

CODIGO

PRODUCTO

CROMO

BRONCE

NEGRO MATE



4159	Monobloc bidet	80,45 €	135,00 €	135,00 €
------	----------------	---------	----------	----------



4168	Grupo de baño ducha completo excéntricas 130/170 mm	165,00 €	260,70 €	260,70 €
------	---	----------	----------	----------



4169	Monobloc Baño ducha completo excéntricas 130/170 mm	114,00 €	194,70 €	194,70 €
------	---	----------	----------	----------



4171	Bateria ducha completa excéntricas 115/155 mm	103,45 €	171,90 €	171,90 €
------	---	----------	----------	----------

4180

Juego llaves paso roscar 1/2"

70,50 €

106,45 €

106,45 €

4181

Juego llaves paso roscar 3/4"

76,50 €

112,45 €

112,45 €

4182

Juego de llaves paso soldar 14,15 y 16 mm

70,50 €

106,45 €

106,45 €

4185

Juego de llaves paso soldar 18 y 22 mm

76,50 €

112,45 €

112,45 €

SERIE TRADICIONAL
Modelo Guadiana

PRECIO

CODIGO

PRODUCTO

GUADIANA



1100

Juego grifos lavabo 1/2"

40,56 €



1101

Monobloc lavabo

43,00 €



1103

Bateria lavabo caño central

52,00 €



1105

Juego grifos bidet 1/2"

37,70 €

SERIE TRADICIONAL
Modelo Guadiana

PRECIO

CODIGO

PRODUCTO

GUADIANA



1106	Monobloc bidet	43,00 €
------	----------------	---------



1110	Juego de llaves de emportar 1/2"	36,00 €
1111	Juego de llaves de emportar 3/4"	38,00 €
1161	Juego de llaves de soldar 14-15-16 mm	36,00 €
1162	Juego de llaves de soldar 18-22 mm	38,00 €



1114	Monobloc baño ducha completo	62,00 €
------	------------------------------	---------



1116	Batería ducha completa (excéntricas 90/130 mm)	47,00 €
1117	Batería ducha completa (excéntricas 130/175 mm)	54,50 €

A close-up photograph of a modern, single-lever chrome faucet. The faucet has a sleek, cylindrical design with a single lever handle on top. Water is flowing from the spout. The background is a textured, light-colored wall. The word "MONOMANDOS" is overlaid in bold black text across the middle of the faucet.

MONOMANDOS



GrifStyl®

SERIE G 3000

PRECIO

CODIGO

PRODUCTO

CROMO



3001CR

Monomando lavado cromo

78,30 €



3003CR

Monomando bidet cromo

78,30 €



3005CR

Monomando baño ducha cromo

125,00 €



3007CR

Monomando ducha completo cromo

95,50 €

CODIGO

PRODUCTO

PRECIO



3002CR	Monomando lavado empotrado cromo	143,00 €
--------	----------------------------------	----------



3008CR	Columna de ducha cuadrada G3000	187,00 €
--------	---------------------------------	----------

3009CR	Columna de ducha cuadrada G3000 con rociador cuadrado inox 250 mm x 250 mm y monomando , conexión con flexo	257,00 €
--------	---	----------



Grif Styl®

SERIE AURA

PRECIO

CODIGO

PRODUCTO

CROMO



201CR

Monomando lavabo cromo

45,00 €



201ACR

Monomando lavado alto cromo

78,25 €



203CR

Monomando bidet cromo

45,00 €



2006CR

Monomando baño ducha empotrar cromo Aura (sin complementos)

61,70 €



2008CR

Monomando ducha empotrar cromo Aura (sin complementos)

48,50 €



Grif Styl®

SERIE AURA

CODIGO

PRODUCTO

PRECIO

CROMO



2005CR

Monomando baño ducha completo Aura 2000
cromo

96,00 €



2007CR

Monomando ducha completo Aura 2000 cromo

70,00 €



2002CR

Monomando lavabo empotrado Aura

78,95 €



Grif Styl®

SERIE AURA

PRECIO

CODIGO

PRODUCTO

CROMO



1519F	Columna de ducha G2000 conexión de flexo con rociador Ø200 acero inox	162,50 €
1519	Columna de ducha G2000 conexión directa con rociador Ø200 acero inox	162,50 €

2009CR	Columna de ducha G2000 con rociador Ø200 acero inox y monomando	215,00 €
--------	---	----------



GrifStyl®

SERIE OMBRIA

PRECIO

CODIGO

PRODUCTO

CROMO



5901CR

Monomando lavabo cromo

60,94 €



5903CR

Monomando bidet cromo

58,40 €



5905CR

Monomando baño ducha completo cromo

84,80 €



5907CR

Monomando ducha completo cromo

64,25 €

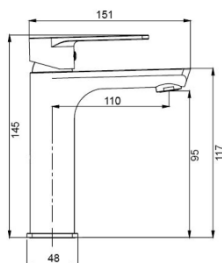

5101NM	Monomando lavabo negro mate	91,80 €
--------	-----------------------------	---------

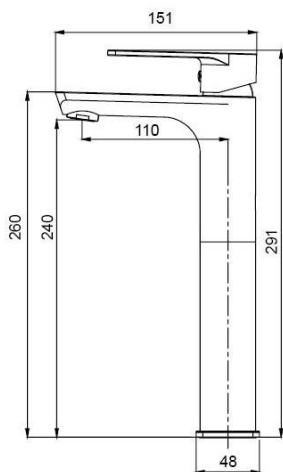
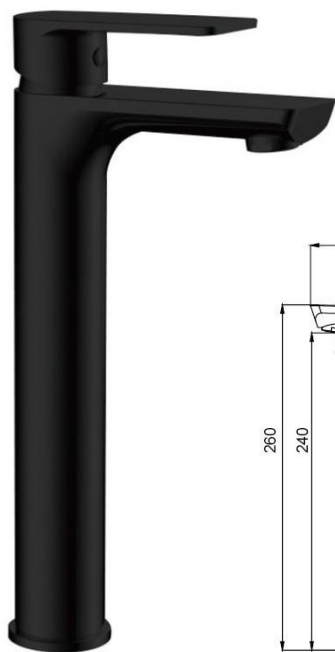

5101ANM	Monomando lavabo alto negro mate	128,55 €
---------	----------------------------------	----------

SERIE GOTA
Acabado negro mate

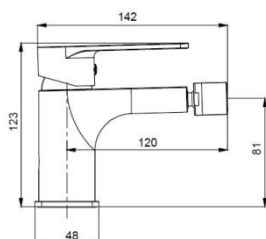

5103NM

Monomando bidet negro mate

91,80 €

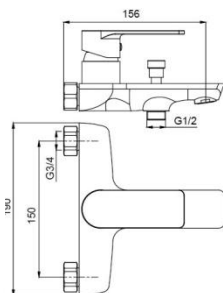

5105NM

Monomando baño ducha completo negro mate

137,70 €

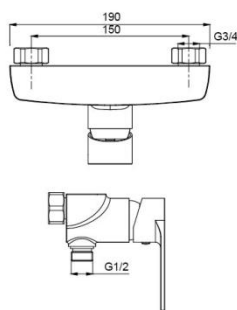

5107CR

Monomando ducha completo negro mate

119,35 €



5001CR	Monomando lavabo cromo	73,00 €
--------	------------------------	---------



5003CR	Monomando bidet cromo	73,00 €
--------	-----------------------	---------



5005CR	Monomando baño ducha completo cromo	110,00 €
--------	-------------------------------------	----------



5007CR	Monomando ducha completo cromo	95,00 €
--------	--------------------------------	---------



Grif Styl®

SERIE ARES

PRECIO

CODIGO

PRODUCTO

CROMO



5301CR

Monomando lavabo cromo

54,00 €



5303CR

Monomando bidet cromo

54,00 €



5305CR

Monomando baño ducha completo cromo

75,00 €

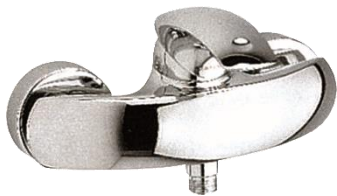

5307CR

Monomando ducha completo cromo

67,00 €



OMEGA



ALFA



BETA



Monomando lavabo

5801CR	ALFA cromo	37,30 €
5601CR	OMEGA cromo	
5501CR	BETA cromo	



Monomando bidet

5803CR	Monomando bidet ALFA cromo	36,70 €
5603CR	Monomando bidet OMEGA cromo	
5503CR	Monomando bidet BETA cromo	



Monomando baño ducha completo

5805CR	ALFA cromo	64,90 €
5605CR	OMEGA cromo	
5505CR	BETA cromo	



Monomando ducha completo

5807CR	ALFA cromo	47,50 €
5607CR	OMEGA cromo	
5507CR	OMEGA cromo	



SERIE



OMEGA



ALFA



BETA

CODIGO

PRODUCTO

PRECIO



Monomando baño ducha empotrar (sin complementos)

5806CR	ALFA cromo	58,20 €
5606CR	OMEGA cromo	
5506CR	OMEGA cromo	



Monomando ducha empotrar (sin complementos)

5808CR	ALFA cromo	45,00 €
5608CR	OMEGA cromo	
5508CR	OMEGA cromo	

Complementos para conjunto de empotrar

PAGINAS 54-56



COCINA

CODIGO

PRODUCTO

PRECIO



Monomando fregadero repisa horizontal

5809CR	ALFA cromo	37,50 €
5609CR	OMEGA cromo	
5509CR	BETA cromo	



Monomando fregadero repisa vertical caño tubo

5810CR	ALFA cromo	50,80 €
5610CR	OMEGA cromo	
5510CR	BETA cromo	



Monomando fregadero repisa vertical caño fundido

5811CR	ALFA cromo	73,90 €
5611CR	OMEGA cromo	
5511CR	BETA cromo	



Monomando fregadero repisa vertical caño cisne

5818CR	ALFA cromo	52,00 €
5618CR	OMEGA cromo	
5518CR	BETA cromo	



GrifStyl®

GRIFERÍA DE COCINA

CODIGO

PRODUCTO

PRECIO



Monomando fregadero extraible

5812CR	ALFA cromo	60,00 €
5612CR	OMEGA cromo	
5812CR	BETA cromo	



Monomando fregadero pared caño bajo (excéntricas 130 x 175 mm)

5814CR	caño tubo ALFA cromo	58,50 €
5614CR	caño tubo OMEGA cromo	
5514CR	caño tubo BETA cromo	



Monomando fregadero pared caño alto (excéntricas 130 x 175 mm)

5816CR	caño tubo ALFA cromo	60,40 €
5616CR	caño tubo OMEGA cromo	
5516CR	caño tubo BETA cromo	
5817CR	caño fundido ALFA cromo	79,40 €
5617CR	caño fundido OMEGA cromo	
5617CR	caño fundido BETA cromo	



Monomando fregadero pared caño tubo alto (excéntricas 90 x 130 mm)

5816CRP	ALFA cromo	65,00 €
5616CRP	OMEGA cromo	
5516CRP	OMEGA cromo	

CODIGO

PRODUCTO

PRECIO



Monomando fregadero repisa vertical caño fundido

5811BC	ALFA Blanco Cromo	86,20 €
--------	-------------------	---------

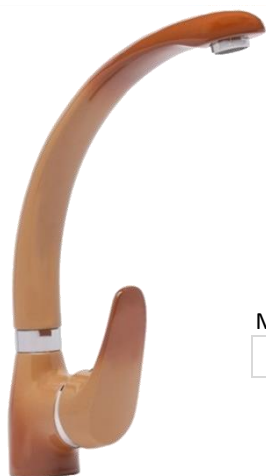

Monomando fregadero repisa vertical caño fundido

5811MC	ALFA Marrón Degradado cromo	99,60 €
--------	-----------------------------	---------



Monomando fregadero repisa vertical caño fundido

5811MB	ALFA Marrón Degradado Brasil cromo	99,60 €
--------	------------------------------------	---------

GRIFERÍA DE COCINA

CODIGO

PRODUCTO

PRECIO



Monomando fregadero repisa vertical caño fundido

5811NM	ALFA Negro Mate cromo	99,60 €
--------	-----------------------	---------



2010CR

Monomando fregadero repisa cisne Aura 2000

57,00 €



2011CR

Monomando fregadero Aura

57,00 €



Grif Styl®

GRIFERÍA DE COCINA

PRECIO

CODIGO

PRODUCTO

CROMO



2014CR

Monomando fregadero **Oronet** cromo

70,00 €



2014CRN

Monomando fregadero **Oronet** negro cromo

80,30 €



2014CRB

Monomando fregadero **Oronet** blanco cromo

80,30 €



2012CRN

Monomando fregadero flexible **Aura** negro cromo

115,00 €



2013CRN

Monomando fregadero flexible **Black**

118,15 €



2015CRN

Monomando fregadero **Ombría** negro Inox articulado

62,15 €

CODIGO

PRODUCTO

PRECIO



1120	Batería fregadero visto vertical (excéntricas 130/175 mm)	62,45 €
------	---	---------



Excéntricas 90 x 130 mm

1121	Batería fregadero caño alto corto 16 cm	38,00 €
1122	Batería fregadero caño alto 20 cm	40,50 €
1125	Batería fregadero caño alto 25 cm	43,00 €
1124	Batería fregadero caño bajo	40,50 €
1130	Batería fregadero caño alto fundido	62,25 €



Excéntricas 130 x 175 mm

1126	Batería fregadero caño alto 20 cm	49,90 €
1127	Batería fregadero caño alto 25 cm	52,40 €
1128	Batería fregadero caño bajo	49,90 €
1134	Batería fregadero caño alto fundido	71,75 €



1139	Monobloc fregadero c/tubo giratorio	49,90 €
------	-------------------------------------	---------



GRIFERÍA DE COCINA - PELUQUERÍA

GrifStyl®

CODIGO

PRODUCTO

CROMO



4174

Bateria fregadero caño alto excéntricas 115/155 mm

106,25 €



4178

Monobloc fregadero caño tubo giratorio

92,63 €



FILTRADO DE AGUA

2017CR

Monomando fregadero **Osmosis**

150,00 €



PELUQUERÍA

2018CR

Grifo peluqueria mango abs

76,25 €



GrifStyl®

GRIFERÍA DE UN AGUA

CODIGO

PRODUCTO

PRECIO



55011CR

Monomando lavado un agua cartucho Ø 25

28,25 €



55012CR

Monomando pared un agua cartucho Ø 25

26,60 €



55013CR

Monomando repisa un agua cartucho Ø 25

26,10 €



55014CR

Conjunto de bidet un agua con mango mini latón con gatillo

64,50 €



GrifStyl®

GRIFERÍA DE UN AGUA

CODIGO	PRODUCTO	PRECIO GUADIANA
--------	----------	--------------------



1143	Grifo giratorio pared caño alto	16,95 €
------	---------------------------------	---------



1146	Grifo repisa giratorio caño vertical	24,70 €
------	--------------------------------------	---------



1148	Grifo fregadero fijo 140 mm	16,65 €
------	-----------------------------	---------

1149	Grifo fregadero fijo 170 mm	16,95 €
------	-----------------------------	---------



1152	Grifo lavadora sencillo 1/2"	11,40 €
------	------------------------------	---------



1154	Grifo lavadora doble 1/2"	23,65 €
------	---------------------------	---------

1155	Grifo lavadora lavavajillas 1/2"	23,65 €
------	----------------------------------	---------



1156	Conjunto lavadora 3/4"	14,60 €
------	------------------------	---------



Grif Styl®

SERIE SANITARIA

CODIGO

PRODUCTO

PRECIO



5701CR

Monomando lavabo cromo

54,10 €



5709CR

Monomando fregadero repisa caño tubo cromo

54,30 €



5710CR

Monomando fregadero repisa vertical cromo

67,60 €

5711CR

Monomando fregadero repisa vertical caño fundido cromo

90,70 €



5714CR

Monomando fregadero pared caño bajo
(excéntricas 130 x 175 mm)

75,30 €



5716CR

Monomando fregadero pared caño alto
(excéntricas 130 x 175 mm)

81,80 €

5717CR

Monomando fregadero pared caño alto fundido
(excéntricas 130 x 175 mm)

96,20 €



REPUESTOS Y COMPLEMENTOS GRIFERÍA

GrifStyl®

CODIGO

MEDIDA

PRECIO

MANGOS DE SET DE DUCHA



Mango ducha **Monza**



13050	negro cromo con codo	3,70 €
13051	blanco cromo con codo	3,70 €
13056	negro cromo sin codo	2,55 €
13057	blanco cromo sin codo	2,55 €



13052	Codo ABS cromo para mango de ducha	1,17 €
-------	------------------------------------	--------



Mango de ducha **Beta** antical



1501	cromo	3,20 €
------	-------	--------



Mango de ducha **Ombria** antical



1502	cromo	4,95 €
------	-------	--------



Mango de ducha **Ares** cinco posiciones



1503	cromo	5,80 €
------	-------	--------



Mango de ducha **Zeus** cinco posiciones antical



1517	Ø150 mm cromo	22,50 €
------	---------------	---------



Mango de ducha **Mistral** cinco posiciones , antical y autolimpiable



1505	cromo	6,10 €
------	-------	--------

CODIGO

MEDIDA

PRECIO

MANGOS DE SET DE DUCHA

Mango de ducha **Aura** antical 

1506	cromo	6,90 €
------	-------	--------

Mango de ducha **G3000** 

1507	cromo	6,90 €
------	-------	--------

Mango de ducha **Styl 1900** 

1508CR	cromo	16,20 €
1508BR	bronce	29,70 €
1508CN	negro con porcelana	36,50 €
1508CP	cromo con porcelana	23,70 €

Mango de fregadero extraíble  

1515	blanco	8,90 €
1516	cromo	10,95 €

Mango Ducha Mini con soporte y gatillo 

1509	blanco	4,60 €
1510	cromo	7,45 €

Mango Ducha Ecológico con Germanio y Turmalina Ø 82mm caja euro colgador 

1511		10,95 €
------	--	---------

Mango Ducha 3 posiciones **Clara** Ø 100 mm caja euro colgador   

1512	cromo	8,20 €
------	-------	--------

CODIGO

MEDIDA

PRECIO

SOPORTES DUCHA



Soporte mango ducha horquilla metálico

13060		4,80 €
-------	--	--------



Soporte mango ducha bayoneta ABS

1520	cromo	1,99 €
------	-------	--------



Soporte mango ducha **Alfa**

1521	cromo	2,75 €
------	-------	--------



Soporte mango ducha **Ares**

1522	cromo	3,50 €
------	-------	--------



Soporte mango ducha **Mistral**

1523	cromo	2,90 €
------	-------	--------

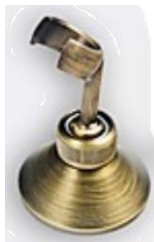

Soporte mango ducha **Styl 1900** metálico

1525CR	cromo	10,25 €
1526BR	bronce	18,95 €
1526CN	negro	18,95 €

CODIGO

MEDIDA

PRECIO



Barra deslizante para ducha

13095	cromo	17,50 €
-------	-------	---------



Tubo para ducha curvo 1/2 cromo

13102	15 cm	5,50 €
-------	-------	--------



Tubo para ducha de 1/2 cromo salida pared

13100	redondo 25 cm	6,95 €
13101	redondo 30 cm	8,65 €
13103	redondo 40 cm	19,10 €
13104	cuadrado 17cm	23,45 €

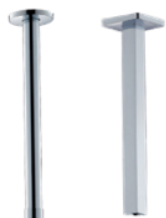

Tubo para ducha de 1/2 cromo salida techo

13094	redondo 20 cm	15,75 €
13113	cuadrado 20 cm	24,60 €



Salida para el flexo redonda empotrada combinada con soporte

13103	cromo	26,20 €
-------	-------	---------



Salida para el flexo cuadrada empotrada combinada con soporte

13104	cromo	27,95 €
-------	-------	---------



REPUESTOS Y COMPLEMENTOS GRIFERÍA

Grif Styl®

CODIGO

MEDIDA

PRECIO



Rociador de ducha con sistema de sonido conexión bluetooth



13011	Ø 220 mm	112,50 €
-------	----------	----------



Rociador para ducha



13105	plástico de 1/2" Ø 50 mm	0,80 €
13106	metálico de 1/2" Ø 60 mm cromo	2,10 €
13107	metálico de 1/2" Ø 90 mm cromo	2,20 €

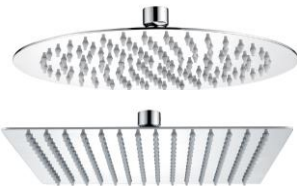

Rociador para ducha con rótula



13108	1/2" Ø 200 mm cromo	28,70 €
13112	1/2" cuadrado 20 x 20 mm cromo	29,80 €



Rociador para ducha con rótula



13109	1/2" antical cromo	6,95 €
-------	--------------------	--------



Rociador para ducha con rótula



13110	1/2" antical cromo	3,55 €
-------	--------------------	--------



Rociador para ducha con rótula 3 posiciones



13111	1/2" antical cromo	5,25 €
-------	--------------------	--------



Rociador para ducha empotrar antivándalico latón



13113	1/2" antical cromo	64,17 €
-------	--------------------	---------

CODIGO

MEDIDA

PRECIO

FLEXOS PARA DUCHA



Flexo acero inoxidable tuercas grafiladas

13080	1,5 mts	4,50 €
13081	2 mts	5,20 €



Flexo acero inoxidable doble engatillado bayoneta

1533	1,5 mts	4,10 €
1534	1,75 mts	4,50 €
1531	2 mts	4,80 €



Flexo acero inoxidable doble engatillado extensible

13091	1,75 mts - 2 mts	5,80 €
13092	1,75 mts - 2 mts (Ø15 mm)	9,15 €



Flexo **latón** bayoneta doble engatillado 1,75 mts

1539BR	bronce	36,50 €
1541CN	negro	36,50 €
13071	cromo	15,95 €
13073	oro	45,00 €



Flexo acero inoxidable doble engatillado para monomando fregadero extraible con plomo

1543	1,2 mts cromo	11,95 €
------	---------------	---------

Todos los flexos y mangos con posibilidad de EURO COLGADOR

EU	euro colgador estándar precio neto	0,30 €
----	------------------------------------	--------

CODIGO

MEDIDA

PRECIO



Juego de codos 3/4 x 58 mm x 30 mm de desplazamiento

1550	chromo	25,00 €
------	--------	---------



Peana para grifo

1554	abs cromado	1,18 €
1555	latón cromado	2,90 €



Llave de apriete de atomizador

1556		1,00 €
------	--	--------



Atomizador dos posiciones con rótula economizador agua, adaptador a M24/100 y M 22/100

13000	BLISTER	3,00 €
-------	---------	--------



Atomizador Flexible economizador agua incluye adaptador a M24/100 y M 22/100

13004	BLISTER	5,75 €
-------	---------	--------



Atomizador latón economizador agua al 50%

13021	Hembra M22/100 cromo	1,20 €
13022	macho M24/100 cromo	1,20 €



Atomizador latón cromo

1561CR	Hembra M22/100 cromo	0,85 €
1562CR	Macho M24/100 cromo	0,85 €
1562BR	Macho M24/100 bronce	3,50 €
1562CN	Macho M24/100 negro	3,50 €
1563CR	Macho M28/100 cromo	1,65 €



Atomizador latón con rótula

1564CR	Hembra M22/100 cromo	3,50 €
1565CR	Macho M24/100 cromo	3,50 €
1565BR	Macho M24/100 bronce	17,50 €
1565CN	Macho M24/100 negro	17,50 €

CODIGO

MEDIDA

UND/BOLSA
/CAJA

PRECIO



Adaptador grifería cromo

13023	M24/100 x M3/4"		3,43 €
13024	H22/100 x M3/4"		2,63 €



Distribuidor baño ducha cromo

1566	1-Monomando		6,25 €
1567	2-Universal para baño-monobloc		6,25 €
1569	3-Monomando empotrar		13,50 €



Juego de excéntricas con plafones Ø 65 mm 3/4" x 1/2" x 10

1570CR	Metálico cromo		6,15 €
1570BR	Metálico bronce		15,20 €
1570CN	Metálico negro		15,20 €

Juego de excéntricas con plafones Ø 80 mm 3/4" x 1/2" x 25

1571CR	Metálico cromo		10,50 €
--------	----------------	--	---------



Plafón excéntrica suelto

13026	Metálico Ø 65 mm cromo		1,25 €
13029	Metálico Ø 80 mm cromo		1,95 €



Conexiones flexibles para monomando

1590	Juego de 35 cm M10/100 x H3/8		5,80 €
1591	Juego de 35 cm M10/100 x H1/2		6,30 €
1592	Juego de 40 cm M10/100 x H3/8		7,38 €
1593	Juego de 40 cm M10/100 x H1/2		7,95 €
1594	Juego de 50 cm M10/100 x H3/8		8,58 €
1595	Juego de 50 cm M10/100 x H1/2		9,15 €



REPUESTOS Y COMPLEMENTOS GRIFERÍA

GrifStyl®

CODIGO

MEDIDA

PRECIO



Monturas cierre goma - soleta

1600	3/8 Brocha 20 estrías altura asiento 26 mm	3,00 €
1601	3/8 Brocha 20 estrías altura asiento 39 mm	3,00 €
1604	1/2 Brocha 20 estrías altura asiento 22 mm	3,40 €
1605	1/2 Brocha 20 estrías altura asiento 26 mm	3,40 €
1606	3/4 Brocha 20 estrías altura asiento 25 mm	5,80 €



Monturas llave empotrar cierre goma - soleta

1609	19/150 Brocha 20 estrías altura asiento 28 mm	3,70 €
1610	19/150 Brocha 20 estrías altura asiento 35 mm	3,80 €
1611	22/150 Brocha 20 estrías altura asiento 35 mm	4,00 €
1612	30/150 Brocha 20 estrías altura asiento 36 mm	6,95 €
1614	1/2 Brocha 20 estrías altura asiento 30 mm	4,80 €



Monturas cierre cerámico

1615	1/2 Brocha 20 estrías altura asiento 22 mm	7,95 €
1616	3/4 Brocha 20 estrías altura asiento 25 mm	14,50 €



Montura llave empotrar cierre cerámico

1617	1/2 Brocha 20 estrías altura asiento 22 mm	11,20 €
------	--	---------



Cartucho monomando cierre cerámico eje durentan malla antiruido

1620	40 Ø eje durentan de 10 x 10,5	8,75 €
1624	35 Ø eje durentan de 10 x 10,5	7,75 €
1625	25 Ø eje durentan de 10 x 10,5	3,75 €



Juego sujeción

1630	2 ejes M6	2,50 €
1631	1 eje, M8	2,50 €



REPUESTOS Y COMPLEMENTOS GRIFERÍA

Grif Styl®

CODIGO**MEDIDA****PRECIO**

Válvula desagüe lavabo - bidet automático completo 1 1/4"

1632CR	cromo	15,55 €
1632BR	bronce	32,00 €
1632CB	cobre	32,00 €

Valvula desagüe lavabo - bidet CLIC CLAC

1633CR	tapón pequeño 1 1/4" cromo	15,35 €
1633BR	tapón pequeño 1 1/4" bronce	21,50 €
1634CR	tapón grande 1 1/4" cromo	17,50 €
1635CR	tapón grande cuadrado 1 1/4" cromo	19,50 €

Cubre cartuchos cromo

1636	Ø40 mm	0,91 €
1637	Ø35 mm	0,91 €

Tuerca aprieta cartuchos

1638	duretan	0,65 €
1639	metal	2,31 €

Manetas monomandos

1640CR	Beta cromo	5,00 €
--------	------------	--------

1641CR	Omega cromo	5,00 €
--------	-------------	--------

1644CR	Alfa cromo	5,00 €
--------	------------	--------

1644BL	Alfa blanco	8,50 €
--------	-------------	--------

1644MD	Alfa marrón degradado	12,50 €
--------	-----------------------	---------

1644CN	Alfa negro	12,50 €
--------	------------	---------

1643CR	Ares cromo	12,00 €
--------	------------	---------

1642CR	Ombria cromo	12,50 €
--------	--------------	---------

CODIGO

MEDIDA

PRECIO

Manetas monomandos



1646CR	Neo cromo	12,50 €
--------	-----------	---------



1647CR	Aura cromo	12,50 €
--------	------------	---------



1648CR	G3000 cromo	16,00 €
--------	-------------	---------



1649CR	Sanitaria cromo	20,00 €
--------	-----------------	---------

Volantes Grifería



1661CR	Guadiana cromo	3,65 €
--------	----------------	--------



1664CR	Styl cromo	12,25 €
1664BR	Styl bronce	19,20 €
1664CN	Styl negro	19,20 €

1670CR	Cubre monturas Styl cromo	4,10 €
1670BR	Cubre monturas Styl bronce	8,30 €
1670CN	Cubre monturas Styl negro	8,30 €



FLUXÓMETROS KRIBA

FLUXÓMETROS KRIBA Y REPUESTOS

CODIGO

MEDIDA

PRECIO

Fluxómetro KRIBA para WC con llave de corte , embellecedor sin bajada acabado cromo

800	3/4"	83,75 €
802	1"	147,45 €

Fluxómetro KRIBA para WC con llave de corte , embellecedor y bajada acabado cromo

801	3/4"	115,90 €
803	1"	179,60 €

Fluxómetro KRIBA para urinario con llave de corte , embellecedor sin bajada acabado cromo

804	1/2"	73,70 €
-----	------	---------

Fluxómetro KRIBA para urinario con llave de corte , embellecedor y bajada acabado cromo

805	1/2"	86,20 €
-----	------	---------

REPUESTOS FLUXOMETROS WC Y URINARIO

Cabezal completo Fluxómetro KRIBA cromo

809	1/2"	32,90 €
810	3/4"	36,50 €
811	1"	44,75 €

Bajada inodoro Ø28 para Fluxómetro KRIBA de WC

812	3/4" - 1"	32,15 €
-----	-----------	---------

Bajada inodoro placa turca sin derramador Fluxómetro KRIBA de WC

813	3/4" - 1"	103,00 €
-----	-----------	----------

Bajada inodoro placa turca con derramador Fluxómetro KRIBA de WC

814	3/4" - 1"	112,00 €
-----	-----------	----------

Bajada completa para Fluxómetro KRIBA de urinario

815	1/2"	12,99 €
-----	------	---------

Plafón cromo para Fluxómetro KRIBA

816	1/2"	2,50 €
817	3/4"	5,70 €
806	1"	5,70 €















Campana - escudo para Fluxómetro KRIBA de urinario

818	1/2"	6,97 €
-----	------	--------

Hembra para bajada en cromo Fluxómetro KRIBA con juntas

819	1/2"	3,95 €
820	3/4"-1"	9,90 €

FLUXÓMETROS KRIBA Y REPUESTOS

	CODIGO	MEDIDA	PRECIO
	Goma de enchufe para urinario Fluxómetro KRIBA		
	821	1/2"	1,65 €
	Junta torica para bajada del Fluxómetro KRIBA		
	822	3/4" - 1"	0,69 €
	Goma de cierre superior para Fluxómetro KRIBA		
	823	1/2"-3/4"-1"	0,45 €
	Goma de cierre inferior para Fluxómetro KRIBA		
	824	1/2"	0,45 €
	825	3/4"	0,67 €
	826	1"	1,43 €
	Portacierre superior para Fluxómetro KRIBA		
	827	1/2"-3/4"-1"	0,95 €
	Portacierre inferior para Fluxómetro KRIBA		
	828	1/2"	1,80 €
	829	3/4"	1,85 €
	830	1"	3,25 €
	Tornillo de cierre inferior para Fluxómetro KRIBA		
	831	3/4" - 1/2"	0,70 €
	832	1"	0,95 €
	Junta perforada para Fluxómetro KRIBA		
	836	1/2"	0,66 €
	837	3/4"	0,66 €
	838	1"	0,95 €
	Aguja de acero con tornillo para Fluxómetro KRIBA		
	839	1/2"	3,05 €
	840	3/4"	3,05 €
	841	1"	3,05 €
	Muelle de pulsador para Fluxómetro KRIBA		
	842	1/2"-3/4"-1"	0,60 €
	Muelle de cámara para Fluxómetro KRIBA		
	843	1"	0,60 €
	Membrana para Fluxómetro KRIBA		
	844	1/2"	3,25 €
	845	3/4"	3,25 €
	846	1"	3,50 €
	Portamebranas para Fluxómetro KRIBA		
	847	1/2"	4,20 €
	848	3/4"	5,50 €
	849	1"	8,60 €
	Porta aguja para Fluxómetro KRIBA		
	850	1/2"	4,20 €
	851	3/4"-1"	4,20 €

TEMPORIZADOS KRIBA - FUENTE

CODIGO

MEDIDA

PRECIO



Grifo lavabo temporizado KRIBA cabezal magnético 1/2 cromo

860	1/2"	38,75 €
-----	------	---------



Llave paso empotrar temporizada KRIBA cromo para ducha-urinario empotrar pre-regulado a 25 / 30 seg

863	1/2" ó para tubo cobre 15"	60,90 €
-----	----------------------------	---------



Llave paso vista temporizada KRIBA cromo para urinario-ducha visto pre-regulado a 25 / 30 seg

864	1/2" ó para tubo cobre 15"	64,70 €
-----	----------------------------	---------



Grifo Urinario temporizado KRIBA cabezal magnético cromo

865	1/2"	29,00 €
-----	------	---------



Grifo frontal fuente pública temporizado KRIBA cromo

862	1/2"	32,50 €
-----	------	---------



Grifo fuente pared temporizado KRIBA cromo

866	1/2"	44,15 €
-----	------	---------



Grifo fuente vertical KRIBA cromo

867	3/8"	44,50 €
-----	------	---------



TEMPORIZADOS KRIBA - PEDALES

Grif Styl®

CODIGO

MEDIDA

PRECIO



Grifo pedal suelo/pared mezclador KRIBA cromo

868

1/2"

92,85 €



Grifo pedal suelo/pared un agua KRIBA cromo

869

1/2"

80,50 €



Grifo doble pedal suelo/pared mezclador KRIBA cromo

870

1/2"

138,20 €



Caño giratorio vertical cromo

871

1/2"

27,00 €



Conjunto pulsador KRIBA para lavabo cromo

875

71,55 €



TEMPORIZADOS G 2000 – G3000

Grif Styl®



Grifo lavabo temporizado cabezal magnético cromo

880	1/2"	61,85 €
-----	------	---------



Grifo lavabo temporizado mezclador cabezal magnético cromo

881	1/2"	71,25 €
-----	------	---------



Grifo lavabo temporizado G3000 cromo

890	1/2"	47,00 €
-----	------	---------



Grifo urinario temporizado G3000 cromo

891	1/2"	36,00 €
-----	------	---------



Grif Styl®

GRIFERIA SENSOR

CODIGO

PRODUCTO

PRECIO

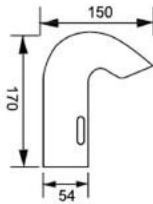

883

Grifo electronico de un agua con sensor , deteccion por infrarrojos , conexión AC220+DC6V

215,40 €

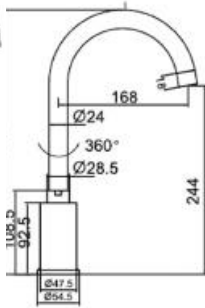

884

Grifo electronico de un agua con sensor , detección por infrarrojos caño cisne , conexión AC220+DC6V

135,16 €

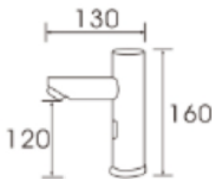

886

Grifo electronico de un agua con sensor redondo , detección por infrarrojos , conexión AC220+DC6V

134,15 €

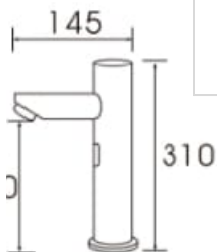

887

Grifo electronico alto de un agua con sensor redondo alto , detección por infrarrojos , conexión AC220+DC6V

157,15 €

JUNTAS - TAPONES - MEMBRANAS

CODIGO MEDIDA UNID.BOLSA PRECIO

Junta de goma plana blanca



10500	3/8"	100	0,10 €
10501	1/2"	100	0,13 €
10502	3/4"	100	0,17 €
10503	1"	100	0,21 €
10504	1 1/4"	100	0,21 €
10505	1 1/2"	100	0,19 €
10506	2"	100	0,20 €

Junta de goma semicónica



10507	3/8" (55 x 14 mm)	100	0,55 €
10508	1/2" (54 x 19 mm)	100	0,40 €
10509	3/4" (59 x 24 mm)	100	0,48 €
10510	1" (66 x 31 mm)	100	0,49 €
10511	1 1/4" (67 x 35 mm)	100	0,49 €
10512	1 1/2" (67 x 44 mm)	100	0,49 €
10513	2" (83 x 53 mm)	100	1,08 €

Junta de goma cónica



10514	3/8" (43 x 13 mm)	100	0,48 €
10515	1/2" (53 x 18 mm)	100	0,48 €
10516	3/4" (58 x 25 mm)	100	0,52 €
10517	1" (59 x 30 mm)	100	0,52 €
10518	1 1/4" (62 x 35 mm)	100	0,52 €
10519	1 1/2" (61 x 40 mm)	100	0,65 €
10520	2" (83 x 54 mm)	100	0,92 €

Goma enchufe inodoro



10521	25 mm	50	1,31 €
10522	30 mm	50	1,31 €

Goma enchufe inodoro de latex

10527	25 mm	50	1,40 €
10528	30 mm	50	1,40 €

Goma enchufe inodoro VICTORIA sin cuello



10523	63 mm	50	1,62 €
-------	-------	----	--------

Goma enchufe inodoro LUCERNA con cuello



10524	∅ exterior 53 mm	50	1,50 €
-------	------------------	----	--------

Goma enchufe inodoro VICTORIA con cuello

10525	∅ exterior 63 mm	50	1,65 €
-------	------------------	----	--------

JUNTAS - TAPONES - MEMBRANAS

CODIGO MEDIDA UNID.BOLSA PRECIO

GOMAS OBTURADOR CISTERNA

Goma obturadora latex con rebosadero

10529	5 mm Ø 45 mm	100	0,65 €
10530	7 mm Ø 45 mm	100	0,65 €

Goma tope rebosadero latex

10533	5 mm	100	0,18 €
10534	7 mm	100	0,18 €

GOMAS OBTURADOR TANQUE BAJO

Goma obturadora plana de latex

10540	ROCA ANT. 22 x 73 x 3 mm	50	0,90 €
10541	ESCALA 20 x 70 x 3 mm	50	0,90 €
10542	ROCA 32 x 65 x 3 mm	50	0,90 €
10543	17 x 65 x 3 mm	50	0,75 €
10544	JACOB 33 x 72 x 3 mm BLANCA	50	0,90 €

Goma obturadora plana con cuello de latex

10545	18 x 63 x 3 mm	50	0,85 €
10546	23 x 49 x 3 mm	50	0,80 €
10547	18 x 67 x 3 mm	50	0,85 €
10548	17 x 72 x 3 mm NEGRA	50	0,90 €

Junta cisterna para inodoro

10549	semicónica 57 x 97 mm	50	1,68 €
10549E	caucho celular 110x80x16	50	1,95 €

Junta entrada agua a urinario

10550	27 x 37 mm	50	1,63 €
-------	------------	----	--------

Goma manguito inodoro cierre

10551	exterior 85 x 125 mm	50	2,05 €
10552	interior 90 x 110 mm	50	2,33 €

Tapón Goma con chapa bombeada acero inox

10560	24 mm	25	0,65 €
10561	28 mm	25	0,65 €
10562	30 mm	25	0,65 €
10563	32 mm	25	0,65 €
10564	34 mm	25	0,73 €
10565	36 mm	25	0,73 €
10566	38 mm	25	0,73 €
10567	40 mm	25	0,75 €
10568	42 mm	25	0,75 €
10569	43 mm	25	0,75 €
10570	44 mm	25	0,75 €
10571	46 mm	25	0,88 €
10572	47 mm	25	0,88 €
10574	50 mm	25	0,95 €
10575	51 mm	25	0,95 €
10576	55 mm	25	1,00 €
10577	61 mm	25	1,13 €
10578	JIMTEM	25	0,85 €
10579	TEKA	25	1,29 €
10580	THOR	25	1,13 €

JUNTAS - TAPONES - MEMBRANAS

CODIGO MEDIDA UNID.BOLSA PRECIO

JUNTAS GOMA CONEXIÓN (Pº/centernar)



Junta cónica conexión

10585	3/8" Ø 10 mm	100	4,85 €
10586	1/2" Ø 10 mm	100	6,80 €



Junta plana conexión

10587	3/8" x 4 x 10 mm	100	4,85 €
10588	1/2" x 4 x 10 mm	100	5,50 €
10589	1/2" x 4 x 12 mm	100	5,80 €
10590	3/8" x 10 x 2 mm	100	2,85 €
10591	1/2" x 10 x 2 mm	100	3,95 €
10592	1/2" x 12 x 2 mm	100	5,20 €
10593	3/4" (24,5 x 16 x 2 mm)	100	6,50 €
10594	1" (29,5 x 20 x 2 mm)	100	6,85 €
10595	1 1/4"(37 x 29 x 2 mm)	100	9,50 €
10596	1 1/2"(44 x 30 x 2 mm)	100	11,90 €
10597	2" (56 x 46 x 2 mm)	100	14,20 €



Junta tuerca flexo ducha

10581	1/2 " (18 x 10 x 2)	100	3,80 €
-------	---------------------	-----	--------

Junta excéntricas batería fregadero

10582	3/4" (24 x 13 x 2,5)	100	5,05 €
-------	-----------------------	-----	--------

JUNTAS GOMA RACOR (Pº/bolsa)



Junta Racor

10600	3/8"	100	2,85 €
10601	1/2"	100	3,95 €
10602	3/4"	100	4,50 €
10603	1"	100	5,65 €
10604	1 1/4"	100	7,30 €
10605	1 1/2"	100	9,65 €
10606	2"	100	11,99 €
10607	2 1/2"	50	13,90 €
10608	3"	50	20,50 €
10609	3 1/2 "	50	24,90 €

JUNTAS - TAPONES - MEMBRANAS

CODIGO MEDIDA UNID.BOLSA PRECIO

SOLETAS GOMA (Pº/centernar)

Soleta goma para valvulita grifo



10610	12 mm	100	2,90 €
10611	14 mm	100	3,40 €
10612	16 mm	100	3,80 €
10613	18 mm	100	4,30 €
10614	20 mm	100	4,90 €
10615	25 mm	100	6,50 €

Soleta goma ciega



10616	12 mm	100	2,90 €
10617	14 mm	100	3,40 €
10618	16 mm	100	3,80 €
10619	18 mm	100	4,30 €
10620	20 mm	100	4,90 €
10621	25 mm	100	6,50 €

JUNTAS TÓRICAS (Pº/centernar)



10625	AN - 1 (2,9 x 6,46 x 1,78)	100	4,50 €
10626	AN - 2 (3,68 x 7,24 x 1,78)	100	4,50 €
10627	AN - 3 (4,47 x 8,03 x 1,78)	100	4,50 €
10628	AN - 4 (5,28 x 8,84 x 1,78)	100	4,50 €
10629	AN - 5 (6,07 x 9,63 x 1,78)	100	4,50 €
10630	AN - 6 (7,65 x 11,21 x 1,78)	100	4,50 €
10631	AN - 7 (9,25 x 12,81 x 1,78)	100	5,50 €
10632	AN - 8 (9,19 x 14,43 x 2,62)	100	5,90 €
10633	AN - 9 (10,77 x 16,01 x 2,62)	100	5,90 €
10634	AN - 10 (12,37 x 17,61 x 2,62)	100	6,20 €
10635	AN - 11 (13,94 x 19,18 x 2,62)	100	6,20 €
10636	AN - 12 (15,54 x 20,78 x 2,62)	100	6,80 €
10637	AN - 13 (17,12 x 22,36 x 2,62)	100	7,80 €
10638	AN - 14 (18,72 x 23,96 x 2,62)	100	7,80 €
10639	3/8" (10 x 16 x 3)	100	6,50 €
10640	1/2" (10 x 19 x 4,5)	100	8,40 €
10641	3/4" (16 x 24 x 4)	100	10,90 €
10642	3/4" (18 x 24 x 3)	100	10,90 €
10643	1" (22 x 29 x 3,50)	100	12,90 €

JUNTAS - TAPONES - MEMBRANAS

CODIGO MEDIDA UNID.BOLSA PRECIO

JUNTAS KLINGER (SIN AMIANTO) (P²/centnar)

Junta racord Klinger

10675	3/8"	100	7,90 €
10676	1/2"	100	10,20 €
10677	3/4"	100	13,50 €
10678	1"	100	18,65 €
10679	1 1/4"	100	26,50 €
10680	1 1/2"	100	35,50 €
10681	2"	100	39,90 €



Junta Klinger tuerca flexo ducha

10685	1/2 " x 10	100	10,30 €
10686	1/2" x 12	100	10,30 €

Junta Klinger excéntricas batería fregadero

10687	3/4 " x 14	100	12,90 €
10688	1" ancha	100	18,90 €

JUNTAS TEFLON P.T.F.E PARA FONTANERIA - CALEFACCION- GAS (P²/bolsa)

Junta racord loco teflón

10690	3/8" (15 x 8 x 1,50)	100	19,90 €
10691	1/2" (19 x 14 x 1,50)	100	20,90 €
10692	3/4" (24 x 20 x 1,50)	100	24,99 €
10693	3/4" (24 x 19 x 1,50)	100	24,99 €
10694	3/4" (24 x 18 x 1,50)	100	24,99 €
10695	7/8" (27 x 22 x 1,50)	100	25,90 €
10696	1" (30 x 24 x 1,50)	100	25,90 €
10697	1 1/4" (39 x 30 x 1,50)	25	13,50 €
10698	1 1/2" (45 x 37 x 1,50)	25	13,50 €
10699	2" (57 x 46 x 1,50)	25	21,25 €
10700	2 1/2" (72 x 56 x 1,50)	25	54,35 €
10701	3" (84 x 64 x 1,50)	25	62,90 €



Junta hembra ancha teflón

10705	3/8" (15 x 7 x 1,50)	100	23,25 €
10706	1/2" (18,5 x 11 x 1,50)	100	23,25 €
10707	3/4" (23 x 13,5 x 1,50)	100	28,50 €
10708	1 " (30 x 20 x 1,50)	100	33,35 €

JUNTAS - TAPONES - MEMBRANAS

CODIGO MEDIDA UNID.BOLSA PRECIO

JUNTAS TEFLON P.T.F.E PARA FONTANERIA - CALEFACCION- GAS (Pº/bolsa)

Junta hembra normal teflón

10715	1/8" (10 x 6 x 1,50)	100	17,35 €
10716	1/4" (12 x 8 x 1,50)	100	18,35 €
10717	3/8" (15 x 10 x 1,50)	100	20,90 €
10718	1/2" (18 x 13,5 x 1,50)	100	21,50 €
10719	3/4" (23 x 19 x 1,50)	25	25,90 €
10720	1" (30 x 24,2 x 1,50)	25	33,35 €
10721	1 1/4" (39 x 30 x 1,50)	25	13,50 €
10722	1 1/2" (45 x 37 x 1,50)	25	13,50 €
10723	2" (56,8 x 45,8 x 1,50)	25	20,99 €



Juntas radiador normal teflón

10730	1" (43 x 33 x 1)	100	35,50 €
10731	tapón 1" (43 x 33 x 1,5)	100	46,55 €
10732	1 1/4" (50 x 41 x 1,5)	25	18,30 €

Juntas gas propano 20/150 teflón

10735	18 x 11 x 1,50	100	23,45 €
10736	18 x 12 x 1,50	100	23,45 €
10737	18 x 12,4 x 1,50	100	23,45 €

MEMBRANA CALENTADOR Y CALDERAS

Membranas COINTRA - AGNI - CORCHO

10740	5 lts antiguo Nº2	10	1,10 €
10741	10 lts antiguo Nº19	10	1,19 €
10742	5 lts moderno Nº1	10	1,15 €
10743	10 lts moderno Nº3	10	1,19 €
10744	Cointra M-5 Nº0	10	1,15 €
10745	Caldera Cointra mod CM-11, CM-15, CM-20 Nº29	10	1,55 €
10746	Caldera Cointra Nº32	10	1,10 €
10747	Caldera Cointra Nº31	10	1,55 €

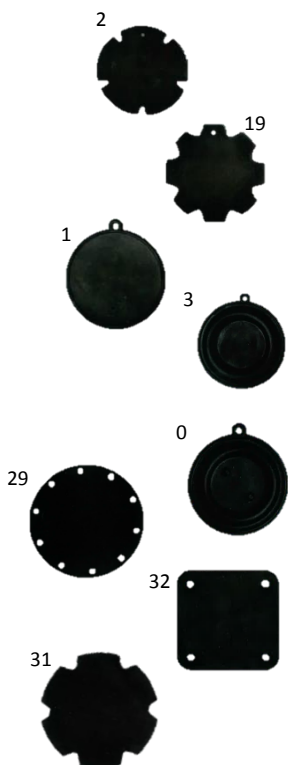

CODIGO MEDIDA UNID.BOLSA PRECIO

MEMBRANA CALENTADOR Y CALDERAS

Membranas FAGOR - ASPES

10748	10 lts antiguo mod. BULES N°8	10	1,19 €
10749	10 lts antiguo mod. 10/TE N°6	10	1,19 €
10750	5 lts antiguo mod.205 DAVID N°4	10	1,10 €
10751	10 lts moderno mod. 10/TE-10k N°7	10	1,19 €
10753	5 lts moderno mod.D-50-D-15 N°33	10	1,15 €

Membranas CORBERO

10754	5 lts moderno mod. C-51-C-52 N°15	10	1,10 €
10755	5 lts antiguo mod. LM-8 presión normal tela interpuesta mod.N°30	10	1,55 €
10756	10 lts antiguo mod. LM-25,26 presión normal tela interpuesta mod.N°36	10	1,55 €
10757	5 lts antiguo mod. LM-8 presión baja sin tela interpuesta mod.N°16	10	1,19 €
10758	10 lts mod. LM-25-26 baja presión sin tela interpuesta mod.N°28	10	1,19 €

Membranas SAUNIER-DUVAL

10759	5 lts moderno N°21	10	1,19 €
10760	10 lts moderno N°23	10	1,19 €

CODIGO MEDIDA UNID.BOLSA PRECIO

MEMBRANA CALENTADOR Y CALDERAS

Membranas JUNKERS

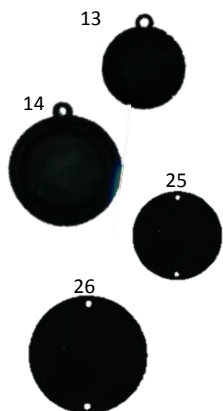

10761	5 lts moderno mod. FD330 N°13	10	1,15 €
10762	10 lts moderno N°14	10	1,19 €
10763	5 lts antiguo N°25	10	1,10 €
10764	10 lts antiguo N°26	10	1,19 €

Membranas BALAY - AITONA - FUIMA

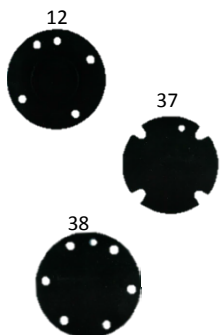

10765	5,7 y 10 lts moderno N°12	10	1,19 €
10766	Alta y Baja presión N°37	10	1,19 €
10767	Alta y Baja presión N°38	10	1,19 €

Membranas VAILLANT

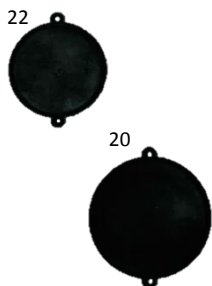

10768	5 lts moderno N°22	10	1,19 €
10769	10 lts moderno N°20	10	1,19 €

Membranas TROPIK



10770	Tropik N°24	10	1,55 €
-------	-------------	----	--------

CODIGO MEDIDA UNID.BOLSA PRECIO

MEMBRANA CALENTADOR Y CALDERAS

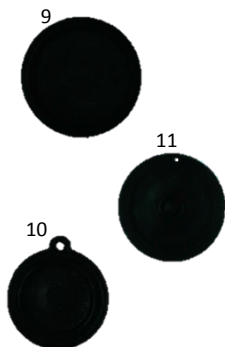

Membranas OTSEIN

10771	5 y 10 lts antiguo mod. Baja presión Nº9	10	1,19 €
10772	5 y 10 lts moderno Nº11	10	1,19 €
10773	5 y 10 lts moderno Nº10	10	1,10 €

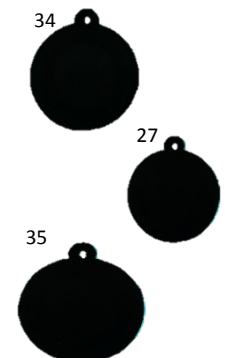

Membranas CHAFFOTEAUX

10774	mod. Roca - Chaffoteaux Nº34	10	1,10 €
10775	5 y 10 lts antiguo Nº 27	10	1,15 €
10776	Chaffoteaux Nº35	10	1,19 €

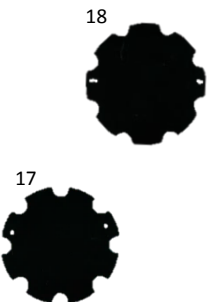

Membranas ORBEGOZO

10777	10 lts antiguo Nº18	10	1,19 €
10778	5 lts moderno Nº17	10	1,19 €



GRIFOS - LLAVES - VÁLVULAS

Grif Styl®

CODIGO

MEDIDA

UND/BOLSA
/CAJA

PULIDO PL

CROMADO CR

PRECIO

LLAVES Y GRIFOS DE JARDIN

Grifo frontal "ITALIC"

11000	1/2"	1		9,30 €
11001	largo 1/2"	1		12,30 €
11002	1/2" con palanca sanitaria	1		17,10 €
11003	largo 1/2" con palanca sanitaria	1		20,05 €

Grifo curvo de latón

11004	1/2"	10	11,18 €	12,55 €
11005	3/4"	10	14,85 €	16,30 €
11006	1"	1	25,10 €	28,10 €

Grifo curvo racord manguera de latón

11007	1/2"x 3/4"	10	12,10 €	13,95 €
11008	3/4"x 1"	10	17,90 €	19,20 €
11009	1" x 1" 1/4	1	28,90 €	31,55 €

Grifo esfera racord manguera

11010	1/2"x 3/4"	10		4,86 €
11011	3/4"x 1"	10		8,98 €
11012	1" x 1" 1/4	1		13,60 €

Grifo esfera racord manguera doble salida

11010D	1/2" x 3/4"x3/4"			14,45 €
--------	------------------	--	--	---------

Grifo regulación lavadora largo

11013	1/2" x 3/4"	2		3,85 €
-------	-------------	---	--	--------

Grifo lavadora escuadra corto

11014	1/2" x 3/4"	2		3,65 €
-------	-------------	---	--	--------

CODIGO

MEDIDA

UND/BOLSA
/CAJA

PULIDO PL

CROMADO CR

LLAVES DE REGULACION

Llave regulación rosca larga con plafón



11015	1/2" x 3/8"	2		3,25 €
11016	1/2" x 1/2"	2		3,50 €

Llave escuadra cromada montura ceramica



11019	redonda 1/2" x 1/2"	2		5,85 €
11018	cuadrada 1/2" x 1/2"	2		8,65 €

Llave regulación con filtro y plafón



11017	1/2" x 3/8"	2		8,30 €
-------	-------------	---	--	--------

Llave regulación doble



11018	1/2" x 3/4" x 3/8"	1		10,30 €
-------	--------------------	---	--	---------

Válvula esfera MINI con palomilla



11025	H-H 3/8"	20		3,93 €
11026	H-H 1/2"	20		4,60 €
11027	H-H 3/4"	20		8,70 €
11030	M-H 3/8"	20		4,10 €
11031	M-H 1/2"	20		4,60 €
11032	M-H 3/4"	20		8,70 €

Válvula esfera H-H con palanca



11035	1/2"	100		4,65 €
11036	3/4"	100		7,80 €
11037	1"	50		11,90 €
11038	1 1/4"			17,45 €
11039	1 1/2"			28,95 €
11040	2"			38,98 €
11041	2 1/2"			90,59 €
11042	3"			111,38 €
11043	4"			206,20 €



GrifStyl®

GRIFOS - LLAVES - VÁLVULAS

PRECIO

CODIGO

MEDIDA

UND/BOLSA
/CAJA

PULIDO PL

CROMADO CR

Válvula esfera mando palanca M-H



11045CR	1/2"	100		7,65 €
11046CR	3/4"	100		10,15 €
11047CR	1"	60		17,05 €

Válvula esfera soldar con palanca



11044	15 mm	100	4,65 €	
11045	18 mm	100	5,97 €	
11046	22 mm	60	8,00 €	
11047	28 mm	50	16,35 €	

Válvula esfera mando palomilla



11380	H-H 1/2"	100		4,65 €
11381	H-H 3/4"	100		7,85 €
11382	H-H 1"	60		11,18 €
11383	M-H 1/2"	60		4,30 €
11384	M-H 3/4"	60		7,08 €
11385	M-H 1"	60		12,30 €

Llave de paso con volante latón cromado



11074	soldar 15 mm	2		10,40 €
11076	soldar 18 mm	2		10,40 €
11077	soldar 22 mm	2		11,40 €
11078	soldar 28 mm	2		19,99 €
11079	roscar 1/2"	2		17,75 €
11080	roscar 3/4"	2		19,99 €

Válvula empotrar esfera con volante metálico redondo cromado



11082	soldar 15 mm	2		15,50 €
11083	soldar 18 mm	2		15,60 €
11084	soldar 22 mm	2		16,50 €
11085	soldar 28 mm	2		29,50 €
11086	roscar 1/2"	2		15,53 €
11087	roscar 3/4"	2		21,42 €
11088	roscar 1"	2		24,30 €



GrifStyl®

GRIFOS - LLAVES - VÁLVULAS

PRECIO

CODIGO

MEDIDA

UND/BOLSA
/CAJA

PULIDO PL

CROMADO CR

Válvula empotrar esfera con volante palanca cromada



11089	soldar 15 mm	2		15,50 €
11090	soldar 18 mm	2		15,60 €
11091	soldar 22 mm	2		16,50 €
11092	soldar 28 mm	2		29,50 €
11093	roscar 1/2"	2		15,53 €
11094	roscar 3/4"	2		21,42 €
11095	roscar 1"	2		24,30 €

Válvula empotrar esfera con volante oculto cromado



11096	soldar 15 mm	2		15,50 €
11097	soldar 18 mm	2		15,60 €
11098	soldar 22 mm	2		16,50 €
11099	soldar 28 mm	2		29,50 €
11100	roscar 1/2"	2		15,53 €
11101	roscar 3/4"	2		21,42 €
11102	roscar 1"	2		24,30 €

Alargadera con tornillo para llave



11103	esfera	1	1,80 €	
11104	soldar	1	1,80 €	

Boca de riego vertical con volante zamac



11105	1/2"	1	12,45 €	
11106	3/4"	1	12,65 €	
11107	1"	1	21,50 €	
11108	1 1/4"	1	46,90 €	
11109	1 1/2"	1	53,50 €	

Boca de riego horizontal con volante zamac



11110	1/2"	1	13,35 €	
11111	3/4"	1	15,15 €	
11112	1"	1	25,48 €	
11114	1 1/2"	1	77,90 €	



Grif Styl®

BOYAS Y FLOTADORES

PRECIO

CODIGO

MEDIDA

UND/BOLSA
/CAJA

PULIDO PL

CROMADO CR

Boya porespan para flotador



11119	3/8" Ø 90 mm Rosca 3/16		0,90 €	
11120	1/2" Ø 110 mm Rosca 3/16		1,50 €	
11121	1/2" Ø 110 mm Rosca 6/100		1,50 €	
11122	3/4" Ø 160 mm Rosca 6/100		2,45 €	

Boya plástico reforzada para flotador



11123	3/8" Ø 90 mm Rosca 3/16		1,15 €	
11124	1/2" Ø 110 mm Rosca 3/16		2,60 €	
11125	1/2" Ø 110 mm Rosca 6/100		2,15 €	
11126	3/4" Ø 130 mm Rosca 6/100		2,78 €	
11127	3/4" Ø 130 mm Rosca 7/100		2,67 €	
11128	1" Ø 150 mm Rosca 6/100		3,55 €	
11129	1" Ø 150 mm Rosca 8/100		3,60 €	
11130	1 1/4" y 1 1/2" Ø 200 mm R 9/100		5,31 €	
11131	2" Ø 230 mm Rosca 9/100		7,18 €	

Boya latón para flotador



11135	3/8" Ø 90 mm Rosca 3/16	1	23,95 €	
11136	1/2" Ø 110 mm Rosca 6/100	1	24,99 €	
11137	3/4" Ø 130 mm Rosca 6/100	1	28,85 €	
11138	3/4" Ø 130 mm Rosca 7/100	1	28,85 €	
11139	1" Ø 150 mm Rosca 8/100	1	35,95 €	

Boya cobre para flotador



11140	1 1/4" Ø 180 mm R 9/100	1	60,10 €	
11141	1 1/2" Ø 200 mm R 9/100	1	62,50 €	
11142	2" Ø 230 mm R 9/100	1	70,95 €	

Boya plana de cobre deslizante



11145	1/2" Ø 120 mm	1	30,50 €	
11146	3/4" Ø 150 mm	1	37,50 €	
11147	1" Ø 170 mm	1	42,90 €	
11148	1 1/4" Ø 200 mm	1	70,65 €	
11149	1 1/2" Ø 230 mm	1	72,60 €	
11150	2" Ø 250 mm	1	78,75 €	
11151	2 1/2" Ø 280 mm	1	123,40 €	
11152	3" Ø 300 mm	1	177,30 €	



Grif Styl®

BOYAS Y FLOTADORES

PRECIO

CODIGO

MEDIDA

UND/BOLSA
/CAJA

PULIDO PL

CROMADO CR

Grifo flotador cazoleta



11115	3/8" Rosca 3/16 con varilla 23 cm	1	4,60 €	
11116	1/2" Rosca 3/16 con varilla 23 cm	1	7,65 €	
11117	3/4" Rosca 6/100 con varilla 25 cm	1	16,05 €	
11118	1" Rosca 6/100 con varilla 25 cm	1	20,95 €	

Grifo flotador guias todo paso varilla recta



11153	1/2" Rosca 6/100	1	8,00 €	
11154	3/4" Rosca 6/100	1	11,95 €	
11155	1" Rosca 8/100	1	19,75 €	
11156	1 1/4" Rosca 9/100	1	50,20 €	
11157	1 1/2" Rosca 9/100	1	58,20 €	
11158	2" Rosca 9/100	1	73,80 €	

Grifo flotador guias todo paso varilla articulada



11189	1/2" Rosca 6/100	1	10,05 €	
11190	3/4" Rosca 6/100	1	13,78 €	
11191	1" Rosca 8/100	1	24,10 €	

Grifo flotador guias todo paso varilla deslizante



11207	1/2"	1	11,20 €	
11208	3/4"	1	16,40 €	
11209	1"	1	24,88 €	
11210	1 1/4"	1	53,20 €	
11211	1 1/2"	1	62,20 €	
11212	2"	1	78,22 €	
11213	2 1/2"	1	474,00 €	
11214	3"	1	862,95 €	

Grifo flotador silencioso para cisterna alta



11240	3/8" Rosca 3/16	1		4,99 €
-------	-----------------	---	--	--------

Grifo flotador silencioso para cisterna baja



11241	3/8" Rosca 3/16	1		5,25 €
-------	-----------------	---	--	--------



Grif Styl®

PLACAS - VÁLVULAS RETENCIÓN - MONTURAS

PRECIO

CODIGO

MEDIDA

UND/BOLSA
/CAJA

PULIDO PL

CROMADO CR

Placa para grifo

11260	macho 1/2"	1	9,95 €	10,50 €
11261	hembra 1/2"	1	9,95 €	10,50 €

Válvula retención

11265	1/2"	1	3,90 €	
11266	3/4"	1	5,80 €	
11267	1"	1	6,90 €	
11268	1 1/4"	1	11,20 €	
11269	1 1/2"	1	15,50 €	
11270	2"	1	22,30 €	

Filtro inoxidable para válvula de retención

11275	1/2"	1	1,10 €	
11276	3/4"	1	1,40 €	
11277	1"	1	1,95 €	
11278	1 1/4"	1	2,30 €	
11279	1 1/2"	1	2,80 €	
11280	2"	1	3,10 €	

Grifo bebecero de cerdo

11350	latón 1/2"	1	3,25 €	
11360	acero inox 1/2"	1		9,40 €

Montura recambio muletilla

11352	1/2"	1	6,00 €	
11353	3/4"	1	6,56 €	
11354	1"	1	11,62 €	
11355	15 mm	1	4,70 €	
11356	16 mm	1	4,70 €	
11357	3/8"	1	4,70 €	
11358	17 mm	1	5,15 €	
11360	19 mm	1	5,65 €	
11361	20 mm	1	6,50 €	
11362	21 mm	1	6,50 €	

Montura recambio con volante zamac

11366	3/8"	1	4,80 €	
11367	18 mm	1	5,10 €	
11368	19 mm	1	4,65 €	
11369	22 mm	1	6,15 €	
11370	26 mm	1	8,30 €	
11372	30 mm	1	11,10 €	

CODIGO

MEDIDA

UND/BOLSA
/CAJA

PULIDO PL

CROMADO CR

Machón doble enlace



12115	3/8" x 3/8"	50	0,60 €	0,75 €
12116RF	1/2" x 1/2" REFORZADO	50	1,47 €	1,51 €
12116	1/2" x 1/2"	50	0,89 €	1,05 €
12117	3/4" x 3/4"	50	1,35 €	1,69 €
12118	1" x 1"	25	2,37 €	2,85 €
12119	1 1/4" x 1 1/4"	10	4,50 €	
12120	1 1/2" x 1 1/2"	10	5,90 €	
12121	2" x 2"	10	8,15 €	
12122	2 1/2" x 2 1/2"	5	19,25 €	
12123	3" x 3"	1	25,60 €	
12124	4" x 4"	1	74,60 €	

Machón doble reducido



12129	1/2" x 3/8"	50	0,85 €	1,00 €
12130	3/4" x 1/2"	50	1,67 €	1,68 €
12131	1" x 1/2"	25	2,35 €	2,66 €
12132	1" x 3/4"	25	2,35 €	2,66 €
12133	1 1/4" x 1/2"	10	4,26 €	
12134	1 1/4" x 3/4"	10	3,65 €	
12135	1 1/4" x 1"	10	4,10 €	
12136	1 1/2" x 3/4"	10	5,30 €	
12137	1 1/2" x 1"	10	5,99 €	
12138	1 1/2" x 1 1/4"	10	5,99 €	
12140	2" x 3/4"	5	8,80 €	
12141	2" x 1"	5	8,80 €	
12142	2" x 1 1/4"	5	8,80 €	
12143	2" x 1 1/2"	5	8,60 €	
12144	2 1/2" x 2"	5	15,25 €	
12145	3" x 2"	1	26,50 €	
12146	3" x 2 1/2"	1	28,90 €	
12147	4" x 2 1/2"	1	84,50 €	
12148	4" x 3"	1	67,80 €	



Grif Styl®

RACORERÍA DE LATÓN ESTAMPADO

PRECIO

CODIGO

MEDIDA

UND/BOLSA
/CAJA

PULIDO PL

CROMADO CR



Machón reducción alargadera

12150	1/2" x 3/8" x 2,5 cm	50	1,40 €	1,70 €
-------	----------------------	----	--------	--------

Alargadera hexagonal (racor marsella)

12155	3/8"	50	0,70 €	0,80 €
12156	1/2" x 1 cm eco	50	0,93 €	1,05 €
12157	1/2" x 1 cm reforzada	50	1,27 €	1,34 €
12158	1/2" x 2 cm	25	1,38 €	1,47 €
12159	3/4" x 1,5 cm	25	1,65 €	1,85 €
12160	1" x 2 cm	25	2,62 €	2,92 €
12161	1 1/4"	10	5,60 €	
12162	1 1/2"	10	8,90 €	
12163	2"	10	12,99 €	



Alargadera hexagonal reducida (racord marsella)

12170	M 3/8" x H 1/2"	50	0,97 €	1,10 €
12171	M 1/2" x H 3/8"	50	1,11 €	1,29 €
12172	M 1/2" x H 3/4"	25	1,55 €	1,78 €
12173	M 3/4" x H 1/2"	25	1,90 €	2,28 €
12174	M 1/2" x H 1"	10	3,25 €	
12175	M 1" x H 1/2"	10	3,15 €	
12176	M 3/4" x H 1"	10	2,40 €	
12177	M 1" x H 3/4"	10	3,55 €	
12179	M 3/4" x H 1 1/4"	10	5,90 €	
12181	M 1" x H 1 1/4"	10	5,90 €	
12185	M 1" x H 1 1/2"	10	7,99 €	
12186	M 1 1/4" x H 1 1/2"	10	8,90 €	
12187	M 1 1/2" x H 2"	10	14,80 €	



Alargadera grifo cilíndrica

12195	3/8" x 30 mm	25	2,40 €	2,80 €
12197	3/8" x 50 mm	10	4,62 €	4,88 €
12199	3/8" x 100 mm	10	6,30 €	6,59 €
12194	1/2" x 20 mm	25	1,90 €	2,05 €
12196	1/2" x 30 mm	25	2,05 €	2,10 €
12198	1/2" x 50 mm	10	2,20 €	2,25 €
12200	1/2" x 100 mm	10	3,56 €	3,71 €
12201	3/4" x 50 mm	10	3,50 €	3,99 €
12202	3/4" x 100 mm	10	5,70 €	6,70 €



CODIGO

MEDIDA

UND/BOLSA
/CAJA

PULIDO PL

CROMADO CR

Aro reducción



12203	1/2" x 3/8"	50	1,10 €	
12204	3/4" x 1/2"	50	1,40 €	

Aro reducción con valona



12205	3/8" x 1/4"	50	0,90 €	1,05 €
12206	1/2" x 1/4"	50	1,25 €	1,40 €
12207	1/2" x 3/8"	50	0,67 €	0,75 €
12208	3/4" x 1/2"	25	1,10 €	1,25 €
12209	1" x 1/2"	25	2,05 €	
12210	1" x 3/4"	25	1,60 €	
12211	1 1/4" x 1/2"	10	4,10 €	
12212	1 1/4" x 3/4"	10	3,80 €	
12213	1 1/4" x 1"	10	3,55 €	
12214	1 1/2" x 1/2"	10	5,45 €	
12215	1 1/2" x 3/4"	10	5,30 €	
12216	1 1/2" x 1"	10	4,99 €	
12217	1 1/2" x 1 1/4"	10	3,27 €	
12218	2" x 1/2"	5	7,99 €	
12219	2" x 3/4"	5	7,39 €	
12220	2" x 1"	5	7,10 €	
12221	2" x 1 1/4"	5	7,80 €	
12222	2" x 1 1/2"	5	6,30 €	
12225	2 1/2" x 1"	1	18,15 €	
12226	2 1/2" x 1 1/4"	1	18,15 €	
12227	2 1/2" x 1 1/2"	1	18,15 €	
12228	2 1/2" x 2"	1	15,90 €	
12232	3" x 1 1/4"	1	23,90 €	
12233	3" x 1 1/2"	1	22,90 €	
12234	3" x 2"	1	22,10 €	
12235	3" x 2 1/2"	1	22,10 €	
12241	4" x 2"	1	61,20 €	
12242	4" x 2 1/2"	1	61,20 €	
12243	4" x 3"	1	61,20 €	

Tapón obturador macho de nylon



12245	1/2"	200	0,15 €	
12246	3/4"	200	0,17 €	



GrifStyl®

RACORERÍA DE LATÓN ESTAMPADO

PRECIO

CODIGO

MEDIDA

UND/BOLSA
/CAJA

PULIDO PL

CROMADO CR

Tapón obturador macho de latón



12247	3/8"	100	0,65 €	0,75 €
12248	1/2"	100	0,80 €	0,90 €
12249	3/4"	50	1,25 €	1,46 €
12250	1"	25	1,78 €	
12251	1 1/4"	10	3,23 €	
12252	1 1/2"	10	3,95 €	
12253	2"	5	5,98 €	
12254	2" 1/2"	1	14,99 €	
12255	3"	1	24,50 €	
12256	4"	1	69,99 €	

Tapón obturador hembra de latón



12260	3/8"	100	0,50 €	0,61 €
12261	1/2"	100	0,59 €	0,72 €
12262	3/4"	50	1,15 €	1,35 €
12263	1"	25	1,90 €	
12264	1 1/4"	10	3,35 €	
12265	1 1/2"	10	4,40 €	
12266	2"	5	6,30 €	
12267	2" 1/2"	1	15,99 €	
12268	3"	1	23,99 €	
12269	4"	1	49,99 €	

Racor depósito uralita largo con tuerca



12271	1/2"	1	2,82 €	
12272	3/4"	1	4,68 €	
12273	1"	1	6,68 €	
12274	1 1/4"	1	8,35 €	
12275	1 1/2"	1	9,65 €	
12276	2"	1	17,08 €	
12277	2" 1/2"	1	51,04 €	
12278	3"	1	95,96 €	

Racor para grifo manguera



12280	1/2"	50	1,35 €	1,76 €
12281	3/4"	25	2,18 €	2,58 €
12282	1"	10	3,20 €	3,70 €
12283	1 1/4"	10	9,90 €	
12284	1 1/2"	10	12,99 €	

Racor rápido para grifo manguera para grifo 1/2



12285PL	hembra 3/4"	1	3,12 €	
12285CR	hembra 3/4"	1		3,45 €

CODIGO

MEDIDA

UND/BOLSA
/CAJA

PRECIO

PULIDO PL

CROMADO CR

Racor Barcelona manguera macho



12286	1/2" x 20 mm	1	7,95 €	
12287	3/4" x 25 mm	1	12,55 €	
12288	1" x 30 mm	1	12,45 €	
12289	1 1/4" x 35 mm	1	24,90 €	
12290	1 1/2" x 45 mm	1	43,60 €	
12291	2" x 60 mm	1	68,50 €	

Racor Barcelona manguera - manguera



12292	20 mm x 20 mm	1	9,05 €	
12293	25 mm x 25 mm	1	16,55 €	
12294	30 mm x 30 mm	1	17,70 €	
12295	35 mm x 35 mm	1	23,55 €	
12296	40 mm x 40 mm	1	43,60 €	
12297	45 mm x 45 mm	1	53,25 €	
12298	50 mm x 50 mm	1	53,78 €	
12299	60 mm x 60 mm	1	75,74 €	

Racor Barcelona macho - macho



12300	1/2" x 1/2"	1	7,10 €	
12301	3/4" x 3/4"	1	8,99 €	
12302	1" x 1"	1	13,60 €	
12303	1 1/4" x 1 1/4"	1	22,45 €	
12304	1 1/2" x 1 1/2"	1	34,60 €	
12305	2" x 2"	1	57,63 €	

Codo empalme manguera



12306	3/4" x 23 Ø	1	11,90 €	
12307	1" x 28 Ø	1	16,50 €	
12308	1 1/4" x 38 Ø	1	18,50 €	
12309	1 1/2" x 44 Ø	1	22,90 €	



Grif Styl®

RACORERÍA DE LATÓN ESTAMPADO

PRECIO

CODIGO

MEDIDA

UND/BOLSA
/CAJA

PULIDO PL

CROMADO CR

Entronque macho manguera latón



12310	3/8" x 12 Ø		1,70 €	
12311	1/2" x 17 Ø		1,95 €	
12312	3/4" x 23 Ø		2,50 €	
12313	1" x 28 Ø		3,68 €	
12314	1 1/4" x 38 Ø		5,45 €	
12315	1 1/2" x 44 Ø		7,50 €	
12316	2" x 56 Ø		10,95 €	
12317	2 1/2" x 70 Ø		34,50 €	
12318	3" x 84 Ø		48,35 €	
12319	4" x 105 Ø		99,80 €	

Racor Manguera tres piezas latón



12320	1/2"		4,70 €	
12321	3/4"		7,75 €	
12322	1"		9,60 €	
12323	1 1/4"		19,60 €	

Empalme unión manguera latón



12325	1/2" x 17 Ø	1	5,20 €	
12326	3/4" x 23 Ø	1	7,30 €	
12327	1" x 28 Ø	1	9,20 €	
12328	1 1/4" x 38 Ø	1	20,90 €	
12329	1 1/2" x 44 Ø	1	20,60 €	

Te empalme manguera



12330	1/2" x 17 Ø	1	8,65 €	
12331	3/4" x 23 Ø	1	10,45 €	
12332	1" x 28 Ø	1	22,90 €	
12333	1 1/4" x 38 Ø	1	33,30 €	
12334	1 1/2" x 44 Ø	1	33,00 €	

Tuerca corredera con valona



12800	3/8"		0,55 €	
12801	1/2"		0,64 €	
12802	3/4"		0,99 €	
12803	1"		1,18 €	
12804	1 1/4"		2,10 €	
12805	1 1/2"		2,78 €	
12806	2"		4,65 €	
12807	2 1/2"		15,35 €	
12808	3"		19,17 €	
12809	4"		76,50 €	



GrifStyl®

ACCESORIOS LATÓN PARA TUBERIA HIERRO

PRECIO

CODIGO

MEDIDA

UND/BOLSA
/CAJA

PULIDO PL

CROMADO CR

Te latón H-H-H (TH 130)



12350	3/8"		1,99 €	
12351	1/2"		2,40 €	
12352	3/4"		3,68 €	
12353	1"		6,35 €	
12354	1 1/4"		10,25 €	
12355	1 1/2"		14,50 €	
12356	2"		19,50 €	
12357	2 1/2"		35,99 €	
12358	3"		60,55 €	
12359	4"		145,85 €	

Te latón reducción H-H-H (TH 130)



12360	3/4" x 1/2" x 3/4"		5,90 €	
12361	1" x 1/2" x 1"		7,50 €	
12362	1" x 3/4" x 1"		7,99 €	
12363	1 1/4" x 1" x 1 1/4"		12,30 €	
12366	1 1/2" x 1" x 1 1/2"		15,20 €	
12367	1 1/2" x 1 1/4" x 1 1/2"		16,95 €	
12369	2" x 1 1/2" x 2"		27,80 €	

Te latón M-H-H (TH 130)



12370	1/2"		6,50 €	
12371	3/4"		8,20 €	
12372	1"		12,99 €	

Codo latón H-H (TH 90)



12373	3/8"		1,65 €	
12374	1/2"		1,99 €	
12375	3/4"		2,99 €	
12376	1"		5,15 €	
12377	1 1/4"		8,05 €	
12378	1 1/2"		10,45 €	
12379	2"		16,99 €	
12380	2 1/2"		27,50 €	
12381	3"		44,50 €	
12382	4"		142,50 €	

Codo latón reducción H-H (TH 90 R)



12384	3/4" x 1/2"		4,15 €	
12385	1" x 1/2"		5,90 €	
12386	1" x 3/4"		5,90 €	
12387	1 1/4" x 1/2"		8,99 €	
12388	1 1/4" x 3/4"		8,99 €	
12389	1 1/4" x 1"		8,99 €	



GrifStyl®

ACCESORIOS LATÓN PARA TUBERÍA HIERRO

PRECIO

CODIGO

MEDIDA

UND/BOLSA
/CAJA

PULIDO PL

CROMADO CR

Codo latón M-H (TH 92)



12390	3/8"		1,60 €	
12391	1/2"		1,95 €	
12392	3/4"		2,90 €	
12393	1"		4,55 €	
12394	1 1/4"		8,50 €	
12395	1 1/2"		9,50 €	
12396	2"		15,90 €	
12397	2 1/2"		31,80 €	
12398	3"		85,30 €	
12399	4"		148,91 €	

Codo latón tres bocas H (TH 221)



12400	1/2"		7,20 €	
12401	3/4"		9,99 €	
12402	1"		13,88 €	

Cruz latón H (TH 180)



12403	1/2"		4,70 €	
12404	3/4"		6,70 €	
12405	1"		10,95 €	
12406	1 1/4"		21,20 €	
12407	1 1/2"		25,80 €	
12408	2"		42,10 €	

Manguito latón H-H (TH 270)



12409	3/8"		1,20 €	
12410	1/2"		1,25 €	
12411	3/4"		2,10 €	
12412	1"		3,30 €	
12413	1 1/4"		5,99 €	
12414	1 1/2"		7,50 €	
12415	2"		11,60 €	
12416	2 1/2"		16,85 €	
12417	3"		26,90 €	
12418	4"		74,56 €	

Manguito latón H-H reducción (TH 240)



12419	1/2" x 3/8"		2,30 €	
12420	3/4" x 1/2"		2,35 €	
12421	1" x 1/2"		3,99 €	
12422	1" x 3/4"		3,20 €	
12423	1 1/4" x 1"		5,40 €	
12424	1 1/2" x 1"		13,25 €	
12425	1 1/2" x 1 1/4"		5,91 €	
12426	2" x 1"		8,75 €	
12427	2" x 1 1/4"		9,15 €	
12428	2" x 1 1/2"		10,05 €	



Grif Styl®

ACCESORIOS LATÓN PARA TUBERÍA HIERRO

PRECIO

CODIGO

MEDIDA

UND/BOLSA
/CAJA

PULIDO PL

CROMADO CR



Te latón de cinco vias

12430	1" x 83 mm	14,50 €
12431	1" x 130 mm	17,50 €

Curva latón 90º H-H (TH 2)



12432	1/2"	9,20 €
12433	3/4"	12,25 €
12434	1"	17,50 €
12435	1 1/4"	29,55 €
12436	1 1/2"	36,30 €
12437	2"	59,50 €
12438	2 1/2"	109,30 €
12439	3"	177,90 €

Curva latón 90º M-H (TH 1)



12441	1/2"	9,20 €
12442	3/4"	12,25 €
12443	1"	17,50 €
12444	1 1/4"	29,55 €
12445	1 1/2"	36,30 €
12446	2"	59,50 €
12447	2 1/2"	109,30 €
12448	3"	177,90 €

Enlace latón tres piezas H-H (TH 340)



12450	1/2"	6,30 €
12451	3/4"	7,90 €
12452	1"	10,30 €
12453	1 1/4"	15,50 €
12454	1 1/2"	18,55 €
12455	2"	25,65 €
12456	2 1/2"	68,50 €
12457	3"	159,90 €

Enlace latón tres piezas M-H (TH 341)



12460	1/2"	7,50 €
12461	3/4"	10,99 €
12462	1"	12,95 €
12463	1 1/4"	16,90 €
12464	1 1/2"	21,55 €
12465	2"	29,80 €
12466	2 1/2"	106,50 €
12467	3"	188,90 €



GrifStyl®

ACCESORIOS LATÓN PARA TUBERÍA HIERRO

PRECIO

CODIGO

MEDIDA

UND/BOLSA
/CAJA

PULIDO PL

CROMADO CR

Collarin de latón ciego



12470	20 Ø			7,50 €
12471	25 Ø			8,60 €
12472	32 Ø			11,24 €
12473	40 Ø			15,95 €
12474	50 Ø			18,20 €
12475	63 Ø			28,70 €
12476	75 Ø			40,15 €

Collarin de latón con toma



12480	1/2 x 20			8,30 €
12481	1/2" x 25			8,90 €
12482	1/2" x 32			11,90 €
12483	3/4" x 32			15,96 €
12484	1/2" x 40			15,90 €
12485	3/4" x 40			16,20 €
12486	1/2" x 50			20,90 €
12487	3/4" x 50			20,90 €
12488	1" x 50			23,90 €
12489	1/2" x 63			34,24 €
12490	3/4" x 63			28,71 €
12491	1" x 63			34,30 €
12492	3/4" x 75			47,72 €
12493	1" x 75			54,33
12494	1/2" x 90			73,50 €
12495	3/4" x 90			75,80 €
12496	1" x 90			75,17 €

Manguito electrolítico H-H



12515	1/2"	25		2,30 €
12516	3/4"	15		3,50 €
12517	1"	10		5,57 €
12518	1 1/4"	2		12,99 €
12519	1 1/2"	2		19,30 €
12520	2"	1		41,99 €
12521	2 1/2"	1		46,40 €
12522	3"	1		65,50 €
12523	4"	1		209,90 €

Conjunto racor contador con junta



12524	1/2" x 1/2"	10		4,90 €
12525	5/8" x 1/2"	10		5,35 €
12526	3/4" x 1/2"	10		4,24 €
12527	7/8" x 1/2"	10		5,20 €
12528	1" x 3/4"	10		6,40 €
12529	1 1/4" x 1"	1		9,85 €
12530	1 1/2" x 1 1/4"	1		18,87 €
12531	2" x 1 1/2"	1		22,20 €
12532	2 1/2" x 2"	1		42,56 €



GrifStyl®

ACCESORIOS LATÓN PARA TUBERÍA COBRE

PRECIO

CODIGO

MEDIDA

UND/BOLSA
/CAJA

PULIDO PL

CROMADO CR

Entronque macho 243 G Cu



12560	3/8" x 15	50	0,85 €	
12561	1/2" x 12	50	1,20 €	
12562	1/2" x 15	50	0,85 €	
12563	1/2" x 16	50	1,07 €	
12564	1/2" x 18	50	0,89 €	
12565	1/2" x 22	50	1,61 €	
12566	3/4" x 15	50	1,75 €	
12567	3/4" x 16	50	2,35 €	
12568	3/4" x 18	50	1,60 €	
12569	3/4" x 22	50	1,65 €	
12570	3/4" x 28	10	2,99 €	
12571	1" x 22	10	2,95 €	
12572	1" x 28	10	2,95 €	
12573	1" x 35	1	5,20 €	
12574	1 1/4" x 28	1	5,40 €	
12575	1 1/4" x 35	1	5,20 €	
12576	1 1/4" x 42	1	6,65 €	
12577	1 1/2" x 35	1	6,73 €	
12578	1 1/2" x 42	1	6,50 €	
12579	2" x 54	1	8,55 €	

Enlace hembra 270 G Cu



12586	3/8" x 15	50	1,05 €	
12587	1/2" x 12	50	1,10 €	
12588	1/2" x 15	50	0,92 €	
12589	1/2" x 16	50	1,14 €	
12590	1/2" x 18	50	0,98 €	
12591	1/2" x 22	50	1,76 €	
12592	3/4" x 15	50	1,76 €	
12593	3/4" x 16	50	2,10 €	
12594	3/4" x 18	50	1,60 €	
12595	3/4" x 22	50	1,75 €	
12596	3/4" x 28	10	2,80 €	
12597	1" x 22	10	2,80 €	
12598	1" x 28	10	3,10 €	
12599	1 1/4" x 28	1	8,20 €	
12600	1 1/4" x 35	1	7,85 €	
12601	1 1/2" x 42	1	9,57 €	
12602	2" x 54	1	13,14 €	



GrifStyl®

ACCESORIOS LATÓN PARA TUBERÍA COBRE

CODIGO

MEDIDA

UND/BOLSA
/CAJA

PRECIO

PULIDO PL

CROMADO CR

Codo hembra 90 G Cu.



12610	3/8" x 15	25	1,60 €	
12611	1/2" x 12	25	1,75 €	
12612	1/2" x 15	25	1,50 €	
12613	1/2" x 16	25	1,99 €	
12614	1/2" x 18	25	2,07 €	
12615	1/2" x 22	25	2,45 €	
12616	3/4" x 15	10	2,90 €	
12617	3/4" x 16	10	2,90 €	
12618	3/4" x 18	10	3,15 €	
12619	3/4" x 22	10	3,60 €	
12620	3/4" x 28	10	4,90 €	
12621	1" x 22	10	5,11 €	
12622	1" x 28	10	6,30 €	
12623	1 1/4" x 28	10	10,85 €	
12624	1 1/4" x 35	1	14,34 €	
12625	1 1/4" x 42	1	17,99 €	
12626	2" x 54	1	27,85 €	

Codo mural hembra 472 G Cu.



12627	1/2" x 12	25	2,99 €	
12628	1/2" x 15	25	2,99 €	
12629	1/2" x 16	25	3,38 €	
12630	1/2" x 18	25	3,38 €	
12631	3/4" x 18	10	5,99 €	
12632	3/4" x 22	10	5,99 €	
12633	1" x 18	10	13,50 €	

Codo macho 92 G Cu.



12634	3/8" x 15	25	1,99 €	
12635	1/2" x 12	25	1,88 €	
12636	1/2" x 15	25	1,88 €	
12637	1/2" x 16	25	2,35 €	
12638	1/2" x 18	25	2,14 €	
12639	1/2" x 22	25	2,61 €	
12640	3/4" x 18	10	2,55 €	
12641	3/4" x 22	10	3,65 €	
12642	1" x 28	10	6,45 €	
12643	1 1/4" x 35	1	14,62 €	
12644	1 1/2" x 42	1	76,72 €	
12645	2" x 54	1	36,90 €	



GrifStyl®

ACCESORIOS LATÓN PARA TUBERÍA COBRE

CODIGO

MEDIDA

UND/BOLSA
/CAJA

PRECIO

PULIDO PL

CROMADO CR

Te hembra 130 G Cu.



12646	3/8" x 15	25	1,99 €	
12647	1/2" x 12	25	2,58 €	
12648	1/2" x 15	25	2,05 €	
12649	1/2" x 16	25	2,70 €	
12650	1/2" x 18	25	2,70 €	
12651	1/2" x 22	25	3,90 €	
12652	3/4" x 18	10	4,50 €	
12653	3/4" x 22	10	5,96 €	
12654	1" x 22	10	7,50 €	
12655	1" x 28	10	8,99 €	
12656	1 1/4" x 35	1	13,80 €	
12657	1 1/4" x 42	1	23,20 €	
12658	2" x 54	1	43,50 €	

Cruz soldar 180 G Cu.



12659	15	10	3,20 €	
12660	18	10	6,99 €	
12661	22	10	11,55 €	
12662	28	1	16,89 €	
12663	35	1	20,50 €	
12664	42	1	30,50 €	
12665	54	1	45,10 €	

Tapón hembra 301 G Cu.



12666	12	25	0,70 €	
12667	14	25	0,99 €	
12668	15	25	1,07 €	
12669	16	25	1,10 €	
12670	18	25	1,29 €	
12671	22	25	1,95 €	
12672	28	25	4,77 €	
12673	35	10	8,99 €	
12674	42	1	12,52 €	
12675	54	1	21,54 €	

Curva desviación 85 G Cu.



12676	15	1	7,55 €	
12677	18	1	8,90 €	
12678	22	1	13,09 €	



GrifStyl®

ACCESORIOS LATÓN PARA TUBERÍA COBRE

CODIGO

MEDIDA

UND/BOLSA
/CAJA

PRECIO

PULIDO PL

CROMADO CR

Empalme unión tres piezas soldar 340 G Cu.



12679	12 x 12	25	2,99 €	
12680	15 x 15	25	3,30 €	
12681	16 x 16	25	4,50 €	
12682	18 x 18	25	4,55 €	
12683	22 x 22	25	6,45 €	
12684	28 x 28	10	11,90 €	
12685	35 x 35	10	15,97 €	
12686	42 x 42	1	24,61 €	
12687	54 x 54	1	39,24 €	

Empalme unión tres piezas hembra soldar 340 G Cu.



12688	3/8" x 15	10	3,90 €	
12689	1/2" x 12	10	3,90 €	
12690	1/2" x 15	10	3,85 €	
12691	1/2" x 16	10	4,90 €	
12692	1/2" x 18	10	4,99 €	
12693	1/2" x 22	10	6,99 €	
12694	3/4" x 15	10	5,50 €	
12695	3/4" x 18	10	5,45 €	
12696	3/4" x 22	10	7,40 €	
12697	1" x 22	10	8,50 €	
12698	1" x 28	5	14,50 €	
12699	1 1/4" x 35	5	18,90 €	
12700	1 1/4" x 42	5	30,86 €	
12701	2" x 54	1	37,50 €	

Empalme unión tres piezas macho soldar 341 G Cu.



12705	3/8" x 15	10	3,95 €	
12706	1/2" x 12	10	4,50 €	
12707	1/2" x 15	10	4,19 €	
12708	1/2" x 16	10	5,50 €	
12709	1/2" x 18	10	5,50 €	
12710	3/4" x 15	10	6,20 €	
12711	3/4" x 18	10	5,99 €	
12712	3/4" x 22	10	9,50 €	
12713	1" x 22	10	10,26 €	
12714	1" x 28	10	14,50 €	
12715	1 1/4" x 35	5	17,97 €	
12716	1 1/4" x 42	5	29,60 €	
12717	2" x 54	1	40,50 €	

ACCESORIOS LATÓN PARA TUBERÍA COBRE

CODIGO

MEDIDA

UND/BOLSA
/CAJA

PRECIO

Racor loco recto solar 359 G Cu.



12718	1/2" x 15	25	1,60 €
12719	1/2" x 18	25	2,10 €
12720	3/4" x 15	25	2,85 €
12721	3/4" x 18	25	2,85 €
12722	3/4" x 22	25	3,40 €
12723	1" x 22	10	4,60 €
12724	1" x 28	10	4,99 €

Racor loco curvo soldar 2A G Cu.



12730	1/2" x 15	25	2,90 €
12731	1/2" x 18	25	3,45 €
12732	3/4" x 15	25	4,80 €
12733	3/4" x 18	25	4,90 €
12734	3/4" x 22	25	5,15 €
12735	1" x 22	10	7,40 €
12736	1" x 28	10	7,99 €

PLAFONES – ARANDELAS – SISTEMAS SUJECCION

Plafón bombeado liso acero inoxidable



13115	3/8" Ø 55 mm	100	0,25 €
13116	1/2" Ø 55 mm	100	0,25 €
13117	1/2" Ø 65 mm	100	0,60 €
13118	3/4" Ø 65 mm	100	0,60 €
13119	1/2" Ø 75 mm	100	1,45 €
13120	3/4" Ø 75 mm	100	1,45 €
13121	con garras 1/2" Ø 55 mm	100	0,28 €

Plafón bombeado con enclavaje acero inoxidable



13122	3/8" Ø 55 mm	100	0,28 €
13123	1/2" Ø 55 mm	100	0,28 €
13124	1/2" Ø 65 mm	100	0,60 €
13125	3/4" Ø 65 mm	100	0,60 €

Arandela zincadas de acero



14007	3/8" x 38 mm	100	0,18 €
14008	1/2" x 45 mm	100	0,21 €
14009	3/4" x 55 mm	100	0,22 €
14010	1" x 66 mm	100	0,37 €
14011	1 1/4" x 66 mm	100	0,53 €
14012	1 1/2" x 78 mm	100	0,59 €
14013	2" x 88 mm	100	0,64 €

CODIGO

MEDIDA

UND/BOLSA
/CAJA

PRECIO

Arandela de latón



14016	3/8" x 38 mm	100	0,72 €
14017	1/2" x 45 mm	100	0,78 €
14018	3/4" x 55 mm	100	1,05 €
14019	1" x 66 mm	100	1,35 €
14020	1 1/4" x 66 mm	100	2,05 €
14021	1 1/2" x 78 mm	100	2,50 €
14022	2" x 88 mm	100	3,75 €



Juego escuadra lavabo reforzada

14025	largo 10 cm	2	1,62 €
-------	-------------	---	--------

Juego tornillos fijación inodoro y bidet cabeza hexagonal cromada de 5 x 75 mm



14030	acero bicromatado	2	0,65 €
14031	latón	2	1,82 €
14032	acero inoxidable	2	1,90 €



Juego tornillos fijación lavabo acero bricomatado

14033	M8 x 100 mm	2	0,99 €
14034	M10 x 100 mm	2	1,40 €



Juego tornillos fijación lateral inodoro gondola acero bricomatado

14035	M6 x 100 mm	2	1,39 €
-------	-------------	---	--------



Juego tornillos fijación lateral inodoro horizontal

14026	tornillo al pavimento de acero inox	2	6,60 €
-------	-------------------------------------	---	--------



Juego tornillos fijación taza tanque

14038	acero inoxidable 6 x 80 mm	2	3,20 €
-------	----------------------------	---	--------



Juego tornillos soporte calentador galvanizado

14039	M8 x 60	2	0,85 €
14040	M8 x 70	2	0,92 €



Juego tornillos palanca cisterna alta galvanizado

14041	M5 x 30	2	0,60 €
-------	---------	---	--------

CODIGO

MEDIDA

UND/BOLSA
/CAJA

PRECIO



Difusor esmaltado salida gases 2 discos

14073	100 mm	64	4,35 €
14074	110 mm	64	4,35 €
14075	120 mm	64	4,35 €



Difusor esmaltado salida gases 3 discos

14076	100 mm	48	4,95 €
14077	110 mm	48	4,95 €
14078	120 mm	48	4,95 €
14079	125 mm	48	5,00 €
14080	130 mm	48	5,35 €



Difusor esmaltado para caldera

14082	130 mm	20	10,45 €
14083	140 mm	20	10,45 €
14084	150mm	20	10,45 €



Soporte frontal contador de gas

14085	21,5 x 11,5 x 6 cm esmaltado	50	3,58 €
14091	acero inoxidable 110	1	60,95 €
14092	acero inoxidable 160	1	60,95 €



Soporte lateral contador de gas

14086	27 x 12 x 6 cm esmaltado	40	4,26 €
14093	acero inoxidable	1	16,60 €



Tapa para contador de gas galvanizada

14087	frontal	50	3,85 €
14088	lateral	40	4,22 €
14090	separadora	30	4,39 €

CODIGO

MEDIDA

UND/BOLSA
/CAJA

PRECIO

REJILLAS PLANAS

Rejilla ventilación plana 10 x 10



14096	aluminio	200	0,99 €
14097	esmaltado blanco	200	1,07 €
14098	aluminio esmaltado blanco	200	1,22 €
14099	aluminio color madera	200	1,30 €

Rejilla ventilación plana 15 x 15



14101	aluminio	250	1,19 €
14102	esmaltado blanco	250	1,35 €
14103	aluminio esmaltado blanco	250	1,40 €
14104	aluminio color madera	250	1,50 €

Rejilla ventilación plana 17 x 17



14106	aluminio	100	1,55 €
14107	esmaltado blanco	100	1,65 €
14108	aluminio esmaltado blanco	100	1,80 €
14109	aluminio color madera	100	1,99 €

Rejilla ventilación plana 20 x 20



14111	aluminio	100	1,80 €
14112	esmaltado blanco	100	1,90 €
14113	aluminio esmaltado blanco	100	1,99 €
14114	aluminio color madera	100	2,20 €

Rejilla ventilación plana 20 X 10



14116	aluminio	100	1,30 €
14117	esmaltado blanco	100	1,39 €
14118	aluminio esmaltado blanco	100	1,44 €
14119	aluminio color madera	100	1,51 €

CODIGO

MEDIDA

UND/BOLSA
/CAJA

PRECIO

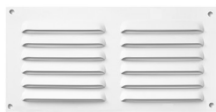

Rejilla ventilación 15 x 30

14121	aluminio	100	1,88 €
14122	esmaltado blanco	100	2,28 €
14123	aluminio esmaltado blanco	100	2,39 €
14124	aluminio color madera	100	2,73 €

REJILLAS EMPOTRAR



Rejilla ventilación empotrar 16 x 16

14126	aluminio	100	2,08 €
14127	esmaltado blanco	100	2,39 €
14128	aluminio esmaltado blanco	100	2,52 €
14129	aluminio color madera	100	2,65 €



Rejilla ventilación empotrar 20 x 20

14131	aluminio	80	2,68 €
14132	esmaltado blanco	80	2,82 €
14133	aluminio esmaltado blanco	80	3,65 €
14135	aluminio color madera	80	3,88 €



Rejilla ventilación empotrar 12 x 24

14137	aluminio	80	2,72 €
14138	esmaltado blanco	80	2,93 €
14139	aluminio esmaltado blanco	80	3,35 €

REJILLAS ABS



Rejilla ventilación fija abs blanca con marco

14141	17 x 17	40	2,60 €
14156	20 x 20	40	3,65 €
14147	22,5 x 9,5	45	2,70 €



Rejilla ventilación fija abs blanca con marco y con cierre

14143	17 x 17	40	3,45 €
14160	20 x 20	40	4,39 €
14149	22,5 x 9,5	45	3,55 €

Rejilla ventilación fija abs blanca con marco, cierre y mosquitera

14148	22,5 x 9,5	45	3,45 €
-------	------------	----	--------



Rejilla ventilación redonda abs blanca con marco

14151	Ø 15 cm	50	2,99 €
-------	---------	----	--------



Grif Styl®

SIFONES – VÁLVULAS – TOMAS LAVADORA

CODIGO

MEDIDA

UND/BOLSA
/CAJA

PRECIO



Sifón flexible abierto

14161	25/30	10	3,85 €
14162	30/30	10	3,85 €
14163	35/35	10	3,85 €
14164	40/40	10	4,99 €



Sifón flexible cerrado

14165	25/30	10	4,10 €
14166	30/30	10	4,10 €
14167	35/35	10	4,10 €
14168	40/40	10	5,30 €



Sifón flexible doble para fregadero

14169		10	11,30 €
-------	--	----	---------



Válvula fregadero completa

14171	30 mm	10	6,20 €
14172	35 mm	10	6,20 €
14173	40 mm	10	6,20 €



Reductor de válvula

14174	1 1/4"	10	2,30 €
14175	1 1/2"	10	2,30 €



Sifón blanco extensible tuerca plástico

14176	1 1/4 x 32/40	10	2,70 €
14177	1 1/2 x 32/40	10	2,70 €



Sifón blanco extensible tuerca latón

14178	1 1/4 x 32/40	10	3,00 €
14179	1 1/2 x 32/40	10	3,00 €



Sifón cromo extensible

14180	1 1/4 x 32/40	10	8,00 €
14181	1 1/2 x 32/40	10	8,00 €



Grif Styl®

SIFONES – VÁLVULAS – TOMAS LAVADORA

CODIGO

MEDIDA

**UND/BOLSA
/CAJA**

PRECIO



Sifón Lux abs cromado

14194	1 1/4	10	21,75 €
-------	-------	----	---------



Sifón lavabo bidé con válvula botella abs (válvula Ø chapa 70)

14185	1 1/2 " incluye reduccion a 1 1/4"	10	5,65 €
14186	1 1/2 " (reducido altura min 130)	10	5,65 €



Sifón lavabo bidé mini sin válvula (para válvula automática)

14188	1 1/4"	10	3,35 €
-------	--------	----	--------



Sifón lavabo bidé "Y" (válvula Ø chapa 70)

14187	1 1/2"	10	5,25 €
-------	--------	----	--------



Sifón curvo extensible completo (válvula Ø chapa 70)

14170	1 1/2"	10	6,50 €
-------	--------	----	--------



Válvula pvc plato de ducha chapa Ø 80

14313	1 1/2"	10	4,26 €
-------	--------	----	--------



Válvula bañera Ø 70 salida horizontal con rebosadero

14314	cromo	10	11,60 €
-------	-------	----	---------

SIFONES – VÁLVULAS – TOMAS LAVADORA

CODIGO

MEDIDA

UND/BOLSA
/CAJA

PRECIO



Válvula fregadero con rejilla y rebosadero (Válvula ø 115. Tapón inox eje central)

14309	1 1/2"	10	12,40 €
-------	--------	----	---------



Válvula fregadero con rejilla ø 115

14409	cromo	10	10,20 €
-------	-------	----	---------



Válvula cesta color con rebosadero para tapón tipo "teka" ø 115

14310	blanco	10	10,70 €
14311	marrón brasil	10	10,70 €
14312	marrón	10	10,70 €



Válvula fregadero color con rejilla color para tapón tipo "teka" ø 115

14410	blanco	10	8,50 €
14411	marrón brasil	10	8,50 €
14412	marrón	10	8,50 €

CODIGO

MEDIDA

UND/BOLSA
/CAJA

PRECIO



Tapón suelto para válvula fregadero

14413BL	blanca	10	2,97 €
14413MB	marrón brasil	10	2,97 €
14413MD	marrón	10	2,97 €
14413IN	inox	10	3,39 €



Manguito desagüe WC abs blanco

14182	110 x 400	10	9,10 €
14183	110 x 600	10	9,30 €
14300	extensible	10	10,05 €



Toma lavadora tuerca plástico

14301	1,5 mts	10	4,25 €
14302	2 mts	10	5,40 €



Toma lavadora tuerca latón

14304	1,5 mts	10	5,99 €
14305	2 mts	10	6,85 €



Desagüe lavadora extensible

14307	0,60 a 1,75 mts	10	3,85 €
14308	con curva 1,70 mts	10	5,10 €

ACCESORIOS INODORO Y CISTERNA

CODIGO

MEDIDA

UND/BOLSA
/CAJA

PRECIO



Descargador plástico cisterna alta

14189	universal	50	3,78 €
-------	-----------	----	--------

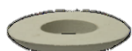

Goma cónica bajante

14193	33 x 36 mm	100	0,48 €
-------	------------	-----	--------



Palanca descargador hierro galvanizado

14195		100	1,00 €
-------	--	-----	--------



Conjunto descargador para cisterna alta completo

14196		20	12,90 €
-------	--	----	---------



Descargador con rebosadero regulable en altura cistena baja universal

14197	compatible con todas las cisternas	20	5,20 €
-------	------------------------------------	----	--------



Campana descargador cistena baja

14198	recambio	20	4,40 €
-------	----------	----	--------



Grif Styl®

ACCESORIOS INODORO Y CISTERNA

CODIGO

MEDIDA

UND/BOLSA
/CAJA

PRECIO



Grifo flotador universal duplo, adaptable a cisternas con entrada vertical o lateral, presentacion caja con eurocolgador

14321	Entrada racor latón 3/8	24	14,47 €
-------	-------------------------	----	---------



Descargador tanque bajo pulsador universal regulable en altura del rebosadero, incluye llave de apriete

14335	compatible con todas las cisternas	12	14,65 €
-------	------------------------------------	----	---------



Descargador tanque bajo doble pulsador orientable, descarga total o parcial (adaptable base Roca) incluye llave de apriete

14331	compatible con todas las cisternas	12	21,95 €
-------	------------------------------------	----	---------



Eje portarrollos plástico

14199		10	0,79 €
-------	--	----	--------



Tirador cisterna alta con cadena

14202	pomo plano blanco	10	1,30 €
14203	pomo redondo blanco	10	1,43 €
14204	espuela metalica cromada	10	1,65 €



Tirador cisterna tanque bajo curvo

14209	pomo abs redondo cromado	10	1,88 €
14210	pomo cónico metálico	10	3,05 €



Tirador cisterna tanque bajo recto

14211	pomo abs redondo cromado	10	1,88 €
14212	pomo cónico metálico	10	3,05 €

ACCESORIOS INODORO Y CISTERNA

CODIGO

MEDIDA

UND/BOLSA
/CAJA

PRECIO



Cisterna tanque alto plástico ☑

14213		50	5,90 €
-------	--	----	--------



Bajante cisterna plástico completa

14214		50	6,80 €
-------	--	----	--------



Codo bajante cisterna plástico

14215		50	3,70 €
-------	--	----	--------



Tapa inodoro blanca UNIVERSAL ECO

14216		12	12,50 €
-------	--	----	---------

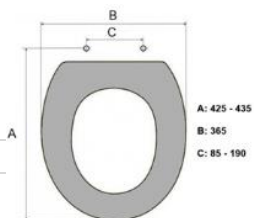

Tapa inodoro blanca HARMONY estuch

14217		10	21,90 €
-------	--	----	---------

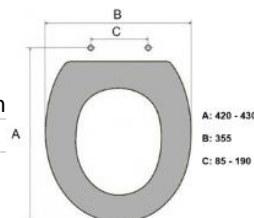

Tapa inodoro blanca CONTINENTAL

14218		10	21,90 €
-------	--	----	---------

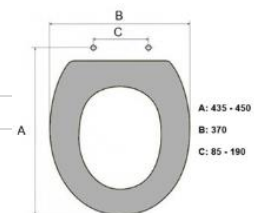



GrifStyl®

ACCESORIOS INODORO Y CISTERNA

CODIGO

MEDIDA

**UND/BOLSA
/CAJA**

PRECIO



Tapa inodoro blanca NEVADA

14220	regleta	10	36,80 €
-------	---------	----	---------

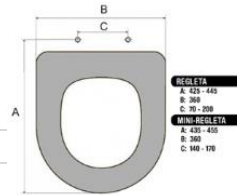

Tapa inodoro blanca LUCIAN

14221		10	36,80 €
-------	--	----	---------

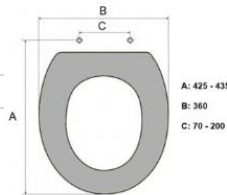

Tapa inodoro blanca MERIDIA con brisagras:

14278	Amortiguada	10	66,83 €
14279	Inoxidable	10	44,55 €

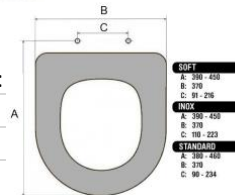

Juego de tornillos tapa inodoro

14222	ABS para la tapa eco - universal	10	2,22 €
14223	Inoxidable para Harmony-Continental	10	7,80 €
14224	Inoxidable para Nevada-Lucian	10	7,80 €



Escobillero baño plastico blanco

14225	Completo	12	4,90 €
14226	Escobilla suelta	12	2,90 €



Embellecedor bidet ciego en ABS

14227	cromo	25	0,60 €
14228	blanco	25	0,38 €



GrifStyl®

ACCESORIOS PVC GRIS

CODIGO

MEDIDA

UND/BOLSA
/CAJA

PRECIO



Manguito conexión inodoro excéntrico

14235	Ø 90 con dos gomas	36	4,50 €
14236	Ø 90	36	3,69 €
14237	Ø 110	36	4,00 €



Manguito conexión inodoro recto

14238	Ø 90 con dos gomas	36	4,50 €
14239	Ø 90	36	3,69 €
14240	Ø 110	36	4,00 €



Injerto para tubo

14241	Ø110/40	250	1,38 €
14242	Ø110/50	250	1,38 €
14243	Ø125/40	250	1,38 €
14244	Ø125/50	250	1,38 €

Codo hembra hembra



14245	Ø32/87'5º	100	0,45 €
14246	Ø32/67'5º	100	0,45 €
14247	Ø32/45º	100	0,45 €
14248	Ø40/87'5º	100	0,55 €
14249	Ø40/67'5º	100	0,55 €
14250	Ø40/45º	100	0,55 €
14251	Ø50/87'5º	100	0,69 €
14252	Ø50/67'5º	100	0,69 €
14253	Ø50/45º	100	0,69 €



Codo macho hembra

14254	Ø40/87'5º	100	0,65 €
14255	Ø110/87'5º	100	2,15 €
14256	Ø110/45º	100	2,15 €



Casquillo reducción

14257	40/32	100	0,42 €
14258	50/40	100	0,45 €



Manguito unión H-H

14259	Ø32	100	0,40 €
14260	Ø40	100	0,45 €
14261	Ø50	100	0,70 €



GrifStyl®

ACCESORIOS PVC GRIS

CODIGO

MEDIDA

UND/BOLSA
/CAJA

PRECIO



Reducción excéntrica

14262	Ø 125/110	72	2,40 €
-------	-----------	----	--------



Tapón

14263	Ø 110-40-40	84	1,45 €
-------	-------------	----	--------



Bote sifónico hermético

14264	altura 90 mm	30	7,80 €
-------	--------------	----	--------



Caldereta sifónica ABS

14266	15 x 15 salida 75/50	8	10,20 €
14267	20 x 20 salida 110/90	8	18,15 €
14268	25 x 25 salida 110/90	8	18,15 €



Sumidero sifónico ABS

14269	10 x 10 salida 50	14	6,20 €
14270	15 x 15 salida 75/50	14	7,70 €
14271	20 x 20 salida 110/90	14	10,20 €
14272	25 x 25 salida 110/90	14	10,20 €



Sumidero latón cromado

14273	6 cm	1	9,40 €
14274	8 cm	1	13,10 €
14275	10 cm	1	18,75 €
14276	12 cm	1	33,75 €



Caldereta sifónica ABS antigravilla

14280	20x20	1	22,40 €
14281	25x25	1	22,40 €



GrifStyl®

CONEXIONES FLEXIBLES ACERO INOXIDABLE

CODIGO MEDIDA UND/BOLSA /CAJA PRECIO

CODIGO MEDIDA UND/BOLSA /CAJA PRECIO

Conexiones malla acero inoxidable Ø 8,5 x 12,6 mm

14500	M 3/8" H 3/8" x 15	10	2,10 €
14501	x 20	10	2,25 €
14502	x 25	10	2,40 €
14503	x 30	10	2,50 €
14504	x 35	10	2,63 €
14505	x 40	10	2,73 €
14507	x 50	10	2,95 €
14508	M 3/8" H 1/2" x 15	10	2,35 €
14509	x 20	10	2,49 €
14510	x 25	10	2,60 €
14511	x 30	10	2,70 €
14512	x 35	10	2,85 €
14513	x 40	10	2,99 €
14515	x 50	10	3,25 €
14516	M 1/2" H 3/8" x 15	10	2,35 €
14517	x 20	10	2,49 €
14518	x 25	10	2,60 €
14519	x 30	10	2,70 €
14520	x 35	10	2,85 €
14521	x 40	10	2,99 €
14523	x 50	10	3,25 €
14524	M 1/2" H 1/2" x 15	10	2,45 €
14525	x 20	10	2,50 €
14526	x 25	10	2,65 €
14527	x 30	10	2,77 €
14528	x 35	10	2,89 €
14529	x 40	10	3,05 €
14531	x 50	10	3,30 €
14532	H 3/8" H 3/8" x 15	10	2,10 €
14533	x 20	10	2,25 €
14534	x 25	10	2,40 €
14535	x 30	10	2,50 €
14536	x 35	10	2,63 €
14537	x 40	10	2,73 €
14539	x 50	10	2,95 €
14540	H 3/8" H 1/2" x 15	10	2,35 €
14541	x 20	10	2,49 €
14542	x 25	10	2,60 €
14543	x 30	10	2,70 €
14544	x 35	10	2,85 €
14545	x 40	10	2,99 €
14547	x 50	10	3,25 €
14548	H 1/2" H 1/2" x 15	10	2,35 €
14549	x 20	10	2,49 €
14550	x 25	10	2,60 €
14551	x 30	10	2,70 €
14552	x 35	10	2,85 €
14553	x 40	10	2,99 €
14555	x 50	10	3,25 €

Conexiones SUPER malla acero inoxidable Ø 13 x 17 mm

14556	M 1/2" H 1/2" x 15	10	4,15 €
14557	x 20	10	4,35 €
14558	x 25	10	4,67 €
14559	x 30	10	4,96 €
14560	x 35	10	5,31 €
14561	x 40	10	5,71 €
14563	x 50	10	6,35 €
14564	H 1/2" H 1/2" x 15	10	4,15 €
14565	x 20	10	4,35 €
14566	x 25	10	4,67 €
14567	x 30	10	4,96 €
14568	x 35	10	5,31 €
14569	x 40	10	5,71 €
14571	x 50	10	6,35 €
14572	M 1/2" H 3/4" x 15	10	4,90 €
14573	x 20	10	5,10 €
14574	x 25	10	5,28 €
14575	x 30	10	5,55 €
14576	x 35	10	5,65 €
14577	x 40	10	5,80 €
14579	x 50	10	6,35 €
14580	M 3/4" H 1/2" x 15	10	4,90 €
14581	x 20	10	5,10 €
14582	x 25	10	5,28 €
14583	x 30	10	5,55 €
14584	x 35	10	5,65 €
14585	x 40	10	5,80 €
14587	x 50	10	6,35 €
14588	M 3/4" H 3/4" x 15	10	4,90 €
14589	x 20	10	5,10 €
14590	x 25	10	5,28 €
14591	x 30	10	5,55 €
14592	x 35	10	5,65 €
14593	x 40	10	5,80 €
14595	x 50	10	6,35 €
14596	H 3/4" H 1/2" x 15	10	4,90 €
14597	x 20	10	5,10 €
14598	x 25	10	5,28 €
14599	x 30	10	5,55 €
14600	x 35	10	5,65 €
14601	x 40	10	5,80 €
14603	x 50	10	6,35 €
14604	H 3/4" H 3/4" x 15	10	4,90 €
14605	x 20	10	5,10 €
14606	x 25	10	5,28 €
14607	x 30	10	5,55 €
14608	x 35	10	5,65 €
14609	x 40	10	5,80 €
14611	x 50	10	6,35 €



MERCANCIA Y PRECIO

La empresa se reserva el derecho de efectuar cualquier modificación que considere oportuna , sin previo aviso y sin que el comprador pueda demandar cualquier tipo de perjuicio. Todos los datos impresos en catálogos sobre cualquier artículo son a título informativo y se facilitan de buena fe. El precio indicado es un PVP recomendado en € y no incluyen IVA.

RESERVA DE PROPIEDAD

Las mercancías entregadas al comprador son de la propiedad del vendedor hasta que se hayan satisfecho las cantidades adeudadas. Ante cualquier impago por parte del comprador, el vendedor podrá proceder a la recuperación de la mercancía.

GARANTIA

Nuestros productos están garantizados por un periodo de 2 años a partir de la fecha de entrega, durante dicho periodo el vendedor se responsabiliza de reemplazar o reparar el artículo en cuestión, siempre que se trate de un defecto de fabricación.

Beterval no se responsabilizará de ningún cargo adicional ,ni de transporte o mano de obra.

En caso de daños que pudiesen ser derivados de nuestros productos estos deberán ser notificados por escrito y con urgencia para tomar las medidas oportunas con nuestra aseguradora, que será la encargada de tramitar el parte de daños, si esta considera que es causante la empresa, siempre previo a una peritación.

La aplicación de la garantía implica cumplir los siguientes términos:

- Que se notifique a la empresa la reclamación y que esta sea reconocida por la misma.

La garantía no cubre los siguientes supuestos :

- Instalación o uso inadecuado del producto y falta de mantenimiento o cuidado del mismo.
- Utilización de productos de limpieza o métodos incorrectos.
- Daños ocasionados por la impurezas del agua que puedan afectar a partes removibles del producto , juntas , monturas, cartucho, filtros
- Desperfectos que se puedan subsanar con repuestos.

DEVOLUCIONES

No se admitirán devoluciones y reclamaciones pasados 30 días de la recepción de la mercancía y siempre que esta sea comunicada a nuestro departamento comercial , al cual habrá que informarle del número de albarán, motivo de la devolución y si debe ser abonada o cambiada.

JURISPRUDENCIA

En caso de litigio , nuestros compradores deberán someterse a la Jurisprudencia de los tribunales y Juzgados de Valencia.



GrifStyl®

BETERVAL S.L.

Carretera Bétera - Olocau, km. 1,2

Apartado 246

46117 Bétera (Valencia)

Teléfono +34 96 160 28 61 · Fax 96 160 28 62

pedidos@beterval.com

www.beterval.com